



FAO-Thiaroye processing technique

Towards adopting improved fish smoking systems in the context of benefits, trade-offs and policy implications in selected developing countries



Cover photograph:

Launch of the FAO-Thiaroye Fish Processing Technique (FTT) in Ghana, December 2014. © FAO/Yvette Diei-Ouadi.

FAO-Thiaroye processing technique

FAO
FISHERIES AND
AQUACULTURE
TECHNICAL
PAPER

634

Towards adopting improved fish smoking systems in the context of benefits, trade-offs and policy implications in selected developing countries

by

Koane Mindjimba

Consultant, Fisheries Economist
Prestation de services et commerce général
Douala, Cameroon

Illia Rosenthal

Consultant, Livelihoods, Institutions, Value Chains and Gender Expert
Food and Agriculture Organization of the United Nations
Rome, Italy

Yvette Diei-Ouadi,

Fishery and Aquaculture Officer
FAO Subregional Office for the Caribbean
Bridgetown, Barbados

Kennedy Bomfeh

Food Safety Risk Assessment Researcher
University of Ghana
Accra, Ghana

and

Aina Randrianantoandro

Consultant, Fisheries Expert
Food and Agriculture Organization of the United Nations
Rome, Italy

Required citation:

Mindjimba, K., Rosenthal, I., Diei-Ouadi, Y., Bomfeh, K. and Randrianantoandro, A. 2019. *FAO-Thiaroye processing technique: towards adopting improved fish smoking systems in the context of benefits, trade-offs and policy implications from selected developing countries*. FAO Fisheries and Aquaculture Paper no. 634. Rome. FAO. 160 pp.
Licence: CC BY-NC-SA 3.0 IGO.

The designations employed and the presentation of material in this information product do not imply the expression of any opinion whatsoever on the part of the Food and Agriculture Organization of the United Nations (FAO) concerning the legal or development status of any country, territory, city or area or of its authorities, or concerning the delimitation of its frontiers or boundaries. The mention of specific companies or products of manufacturers, whether or not these have been patented, does not imply that these have been endorsed or recommended by FAO in preference to others of a similar nature that are not mentioned.

The views expressed in this information product are those of the author(s) and do not necessarily reflect the views or policies of FAO.

ISBN 978-92-5-131469-2
© FAO, 2019



Some rights reserved. This work is made available under the Creative Commons Attribution-NonCommercial-ShareAlike 3.0 IGO licence (CC BY-NC-SA 3.0 IGO; <https://creativecommons.org/licenses/by-nc-sa/3.0/igo/legalcode/legalcode>).

Under the terms of this licence, this work may be copied, redistributed and adapted for non-commercial purposes, provided that the work is appropriately cited. In any use of this work, there should be no suggestion that FAO endorses any specific organization, products or services. The use of the FAO logo is not permitted. If the work is adapted, then it must be licensed under the same or equivalent Creative Commons licence. If a translation of this work is created, it must include the following disclaimer along with the required citation: "This translation was not created by the Food and Agriculture Organization of the United Nations (FAO). FAO is not responsible for the content or accuracy of this translation. The original [Language] edition shall be the authoritative edition."

Disputes arising under the licence that cannot be settled amicably will be resolved by mediation and arbitration as described in Article 8 of the licence except as otherwise provided herein. The applicable mediation rules will be the mediation rules of the World Intellectual Property Organization <http://www.wipo.int/amc/en/mediation/rules> and any arbitration will be conducted in accordance with the Arbitration Rules of the United Nations Commission on International Trade Law (UNCITRAL).

Third-party materials. Users wishing to reuse material from this work that is attributed to a third party, such as tables, figures or images, are responsible for determining whether permission is needed for that reuse and for obtaining permission from the copyright holder. The risk of claims resulting from infringement of any third-party-owned component in the work rests solely with the user.

Sales, rights and licensing. FAO information products are available on the FAO website (www.fao.org/publications) and can be purchased through publications-sales@fao.org. Requests for commercial use should be submitted via: www.fao.org/contact-us/licence-request. Queries regarding rights and licensing should be submitted to: copyright@fao.org.

Preparation of this document

The document takes stock of the developments since the validation in 2011, and subsequent promotion of, the first proven disruptive hot-smoking technique of fish in the tropics: the FAO-Thiaroye processing technique (FTT). This document draws lessons from the use of the FTT in different contexts to formulate guidance in supporting decisions for its effective dissemination. These action-oriented recommendations aim to unleash the FTT's potential to actually meet the purpose of its development, i.e. ensuring food safety and environmental protection while enhancing post-harvest operators' well-being (income and health) and broader national economic development through earning increased trade revenue. Similarly, the FTT is geared to help empower women, who make up a large segment of post-harvest actors, by reducing post-harvest losses through more efficient processing and reduced operational costs (including curbing fuelwood use) while fostering decent working conditions.

Indeed, an urgent need to improve safety of smoked fish consumers was highlighted at the Meeting of Professionals / Experts in Support of Fish Safety, Technology and Marketing in Africa held in Elmina, Ghana, on 14–16 November 2017 (the Elmina meeting). At the Elmina meeting, a specific session was dedicated to the benchmarking of smoking systems to develop a reference for the necessary features of a typical kiln that supports food safety, decent work and environmental sustainability. This was followed by a meeting on 17 November of the representatives of beneficiary countries of the FAO Multipartner Programme Support Mechanism Project Enable Women to Benefit More Equally from Agri-Food Chains (FMM/GLO/103/MUL). Here, public institutions and smallholder fishery organizations shared their experiences with the FTT, and discussed key enabling conditions for the successful scale-up of the innovation. The deliberations from the two meetings came out with a strong recommendation for the preparation of a concise document to illustrate the potential benefits of using improved fish smoking techniques such as the FTT in addressing safety and quality issues.

Soon after the Elmina meeting, a working group comprising resource people knowledgeable about fish smoking techniques, gender and institutional issues, and food safety standards was commissioned. The group was tasked with writing a document that could enlighten development practitioners, policy- and decision-makers in their pursuit of the food safety of their populations while also safeguarding food safety elsewhere and that of consumers in partner markets. The first draft was produced in June 2018, then reviewed by several key informants, technical experts and persons vested in development and policy advisory services.

However, this document is not designed as a definitive guiding tool for the process of widespread adoption of proven efficient fish processing systems such as the FTT. Rather, it should be seen as a resource material that can encourage greater efforts to understand and reduce pitfalls during adoption, particularly in the context of small-scale fisheries. With this in mind, and also as to further enrich and refine the document, the authors look forward to receiving feedback from those who adopt the FTT and gather additional lessons from their experience when using it in their geographical context.

Abstract

More than 60 percent of global production of smoked fishery products occurs in Africa and Asia, highlighting their tremendous significance in food and nutrition security and as a vehicle for livelihood support in these regions. However, prevailing processing technologies entail significant deleterious health implications for both processors and consumers. The main hazard relates to polycyclic aromatic hydrocarbons (PAHs), which are known to have carcinogenic potential. In response to the PAH challenge and leveraging on the Codex Alimentarius Code of Practice guidelines for preventing their occurrence in smoked and dried products, the FAO-Thiaroye fish processing technique (FTT) was developed under a collaborative research approach between FAO and a fisheries institution in Senegal. To date, the FTT has been introduced in 16 countries. The technique addresses the PAH problem, and yields products that comply with international limits on the hazard, while fostering many social, economic and environmental benefits. However, experience from some African and Asian countries points to the need for a context-driven balance that ensures that the gains associated with its use can be realized without making expensive compromises, especially in terms of fisheries resources status and trade dynamics. Policy and regulatory frameworks need to be informed by a risk-based approach and supportive of consistent benchmarking and differentiation of FTT products. This document reviews the lessons from those countries, and makes the case for a hard, evidence-based, policy backbone to safeguard the sustainable, eco-friendly supply of safe smoked (and dried) fishery products to support food security, particularly in the developing world.

Contents

Preparation of this document	iii
Abstract	iv
Acknowledgements	x
Abbreviations and acronyms	xiiI
Executive summary	xv
Chapter 1 - Introduction	1
Chapter 2 - Fisheries resources and supply pattern in selected countries	5
Introduction	5
Resources – global picture	5
National statistics on production, drying, salting and smoking	6
Trade statistics	12
Conclusion and way forward	12
Chapter 3 - Advances in fish smoking systems: from traditional kilns to the FTT	15
Introduction	15
Emergence of the first generation of improved kilns to address critical inefficiencies in traditional smoking systems: the era of the Chorkor smoker	15
Meeting specific sociocultural needs within the operational context of the Chorkor kiln	16
New scientific evidence and market-access-driven development of the second generation of improved kilns: development of the FTT	17
Conclusion	20
Chapter 4 - Technical features of the specific components of the FTT	21
Introduction	21
The FTT and the problem of polycyclic aromatic hydrocarbons (PAHs)	21
The FTT-Dafing	22
Conclusion	23
Chapter 5 - Comparative advantages of the FTT over traditional fish smoking systems	25
Introduction	25
Comparing the FTT with traditional fish smoking systems	25
Comparative SWOT of the FTT and traditional systems	27
Conclusion	30

Chapter 6 - Benefits of the FTT	31
Introduction	31
Safety of FTT products, consumer protection	31
Reduction of post-harvest losses	36
Decent working conditions, reduced occupational safety and health risks, and other social assets for value-chain actors	38
Environmental protection	43
Financial and economic benefits	46
Conclusion and way forward	48
Chapter 7 - Trade-offs and challenges	51
Introduction	51
State of fisheries and aquaculture with regard to further dissemination of the FTT	51
Upfront investment and the creation of an enabling business environment	53
Consumer acceptance of FTT products	55
The need for livelihood-sensitive communication on the benefits of the FTT and the challenges of traditional kilns	56
Market environment and access	56
Conclusion and recommendations	64
Chapter 8 - Experience with regard to dissemination of the FTT across sub-Saharan Africa and Asia	67
Introduction	67
Introduction of the FTT in sub-Saharan Africa and Asia	67
Countries contemplating introducing the FTT	75
Conclusion	75
Chapter 9 - Key policy-support elements arising from the FTT case studies	77
Introduction	77
FTT adoption process	77
Preconditions for success	83
Lessons learned	84
Policy implications	100
Conclusion	106
Chapter 10 - Conclusions and recommendations	109
Conclusions	109
Recommendations	112
References	119
Annex 1	
Summary of preconditions for success of FTT projects	133
Annex 2	
Summary of lessons learned from FTT projects in selected sub-Saharan African and Asian countries, with recommendations for later project stages and future projects	135

Tables and Figures

Tables

Table 1.	Percentage of total fisheries production that was processed in selected African countries in 2015	8
Table 2.	Percentage of total fisheries production that is processed in selected Asian countries in 2015	11
Table 3.	UN Comtrade world export figures of cured, smoked or meal fishery products	13
Table 4.	Comparison of the FTT with other fish smoking systems	28
Table 5.	SWOT analysis of the FTT and traditional fish smoking systems	29
Table 6.	PAH4 levels in smoked-dry <i>Sardinella</i> sp. (FTT vs traditional kilns)	33
Table 7.	Margin of exposure for B(a)P in <i>Sardinella</i> sp. and <i>Sphyraena</i> sp. smoked using the FTT and traditional kilns in Ghana	36
Table 8.	ASFF notifications on unacceptable PAH levels in smoked fish exports from selected African countries and one Asian country to the European Union (Member Organization), 2006–2018	38
Table 9.	Gaseous-pollutant measurements at an FTT platform in Côte d'Ivoire, 2016	41
Table 10.	Types and characteristics of fuels that have been tested with the FTT	45
Table 11.	Value added from smoking fishery products and income-generating activities with a typical FTT kiln on the Abobo-Doumé platform, Côte d'Ivoire, in 2015	47
Table 12.	Cost–benefit analysis comparison between traditional and FTT smoked products in Sri Lanka	48
Table 13.	Africa and Asia – share in world fisheries production, 2015	52
Table 14.	Africa and Asia – share in world fisheries imports and exports, 2015	52
Table 15.	Upfront investment in FTT components in Côte d'Ivoire, as of 31 December 2015	54
Table 16.	Upfront investment of FTT kilns in Côte d'Ivoire, as of 31 December 2015	54
Table 17.	Inventory of FTT kilns in sub-Saharan African and Asian countries, as of 31 May 2018	75
Table 18.	Distribution of scores and ranking of factors determining FTT adoption in Cameroon, Côte d'Ivoire and the United Republic of Tanzania	78
Table 19.	Checklist for policymakers for the establishment of FTT infrastructure	85
Table 20.	Checklist for programme designers and managers of FTT infrastructure	86

Figures

Figure 1.	Dried, smoked or salted fish for all continents, 2015	5
Figure 2.	National fisheries production in selected African countries, 2015	7
Figure 3.	Production of dried, salted or smoked fish in selected African countries, 2015	7
Figure 4.	Marine fisheries in selected WAEMU countries – first-rank household source of revenue in 2014	9
Figure 5.	Marine fisheries in selected WAEMU countries – second-rank household source of revenue in 2014	9
Figure 6.	Inland fisheries in selected WAEMU countries – contribution of the different activities to households’ total revenue in 2012	9
Figure 7.	National fisheries production in selected Asian countries, 2015	10
Figure 8.	Production of dried, salted or smoked fish in selected Asian countries, 2015	11
Figure 9.	Rush hut stove in the Democratic Republic of the Congo	16
Figure 10.	Drum-type stove in Ghana	16
Figure 11.	Mud stove / traditional Dafing in Burkina Faso	16
Figure 12.	Chorkor kilns in Ghana	16
Figure 13.	Banda oven in Burundi	17
Figure 14.	Hybrid Banda in Burundi	17
Figure 15.	Altona oven in Burundi	17
Figure 16.	Detachable and portable single compartment Banda for flood-prone areas in the Congo	17
Figure 17.	AFSMO–150 improved fish smoking kiln in a fishing village near Accra, Ghana	18
Figure 18.	Launch of the FTT in Ghana	19
Figure 19.	A typical FTT-Dafing in Burkina Faso	19
Figure 20.	Technical features and components of the FTT	22
Figure 21.	FTT-Dafing used in Burkina Faso	23
Figure 22.	Traditionally smoked fish in Likouala-Mossaka fishery in the Congo (L) and smoked fish derived from FTT	26
Figure 23.	Mean B(a)P levels in smoked-dry <i>Sardinella</i> sp. (FTT vs traditional kilns)	33
Figure 24.	Predicted world population growth by 2050	53
Figure 25.	Evolution factors for the smoked fish global market from 2017 to 2021	57
Figure 26.	Fish being sold at Nouakchott central market, Mauritania	63
Figure 27.	Fish processor selling dried bycatch in Ambila, Madagascar	63
Figure 28.	Dissemination of FTT kilns across sub-Saharan African and Asian countries, as of 31 May 2018	68
Figure 29.	FTT Banda kiln at the Ngolome post-harvest technological platform in Angola operated by a fish processor trained under TCT/ANG/3403	69
Figure 30.	FTT Banda kilns in Bujumbura, Burundi, operated by a fish processor under the guidance of a technician	69
Figure 31.	FTT Banda kilns under a shed in Londji near Kribi in Cameroon	69

Figure 32.	Women fish processors using FTT Banda kilns in Braffedon platform in Côte d'Ivoire	69
Figure 33.	Women fish processors at Timenetaye fish smoking centre in Conakry, Guinea, using newly installed FTT kilns	69
Figure 34.	Group of women fish processors in Cacheu, Guinea-Bissau, taking part in a practical demonstration of an FTT kiln newly installed in their community	69
Figure 35.	Women fish processors in Unnichchai, Batticaloa District, Sri Lanka, using a newly installed FTT kiln in their community	70
Figure 36.	Participants using charcoal to smoke fish on FTT kilns installed in their community in the United Republic of Tanzania	70
Figure 37.	Factors determining FTT adoption in selected sub-Saharan African countries, including Cameroon, Côte d'Ivoire and the United Republic of Tanzania taken altogether (a), and separately: Cameroon (b), Côte d'Ivoire (c)	79

Acknowledgements

FAO wishes to thank all those who have made this publication a reality – first, the authors, then Mrs Oumoulkhairy Ndiaye, the innovator of the FTT, all the participants in the Elmina meeting and case study teams of experts in the various countries, whose contributions have been instrumental in inspiring this document. The teams in the case studies discussed were as follows:

Angola

Mr Bernardo S. Cazembe, Rural Development and Fisheries Division, Municipal Administration, Moxico Province; Mr Koane Mindjimba, Fisheries Economist Consultant; Dr Nsuka K. Ndongala, Institute of Artisanal Fisheries and Aquaculture Development, Uíge Province; and Mr Bomba B. Sangolay, TCP/ANG/3403 Support to Small-scale Inland Fisheries: Dissemination of Post-Harvest Techniques in the North-West of Angola.

Burkina Faso

Mr Louis-Bernard M. Akoun, FAO Agribusiness Development, Capacity Development Consultant; Mr Lassina Konate, Economist Consultant; Ms Salya Kone, Sociologist, Gender Specialist Consultant; and Mr Yacouba Ouedraogo, Fisheries Scientist and Sociologist, Multipartner Programme Support Mechanism National Focal Point.

Cameroon

Mr Ghislain N. Etamé, National Institute of Cartography; Mr Stevin F. Kammalac, National Institute of Statistics; Mr Koane Mindjimba, Fisheries Economist Consultant; Mr François Tiotso, Fisheries Management Consultant; and fisheries extension workers: Ms Martha Eseng, Nursery and Fisheries Control Centre (CACP), Bambalang; Mr Rigobert N. Kouokom, Fisheries Centre, Yoyo; and Mr Saïdou Saliou, CACP, Lagdo.

Côte d'Ivoire

Mr Louis-Bernard M. Akoun, FAO Agribusiness Development, Capacity Development Consultant; Prof Kouassi P. Anoh, Department Head, Tropical Geography Institute, Université Félix Houphouët-Boigny (UFHB); Dr Donikpo Coulibaly, Animal and Fisheries Resources National Expert, FAO Office in Côte d'Ivoire; Dr Labla J. Diomandé, Director, Training, Extension and Products Valorization Directorate (DF2V), Ministry of Animal and Fisheries Resources (MIRAH); Ms Katrien Holvoet, Fisheries and Gender Consultant; Mr Koane Mindjimba, Fisheries Economist Consultant; Mr Jean M. Monney, Deputy Director, DF2VP/MIRAH; Prof Souliho Ouattara, UFHB Health Centre; Prof Karim S. Traoré, Deputy Director, Scientific and Technical Department, Laboratoire National d'Appui au Développement Agricole; and Ms Antoinette Ziehi, ex-FAO Programme Assistant, now retiree FAO Côte d'Ivoire.

Democratic Republic of the Congo

Mr Guy Bungubetshi, Fishery Products Processing and Preservation National Consultant (Agir Alternatif [non-governmental organization]).

Ghana

Study team “Meeting Food Safety Targets in Shifting from Traditional to New Fish Smoking Systems: A Case Study in Ghana” comprising: Mr Kennedy Bomfeh, University of Ghana; Prof Dr Ir Bruno De Meulenaer, Ghent University, Belgium; Prof Dr Ir Liesbeth Jacxsens, Ghent University, Belgium; Prof Emmanuel O. Afoakwa, University of Ghana; Prof Wisdom K. Amoa-Awua, Food Research Institute, Ghana;; and Ms Isabella Tandoh, University of Ghana.

Sri Lanka

Mr Bandara Rotawewa, Programme Officer, Agriculture Development Officer, FAO Office in Sri Lanka.

United Republic of Tanzania

Mr Yahya I. Mgawe, Chief Executive Officer (CEO), Fisheries Education Training Agency (FETA); Mr Koane Mindjimba, Fisheries Economist Consultant; and fisheries extension workers: Mukama C.Ndaro, Nyegezi; Hashimu Tengeni, Sengerema; Self B. Nyambika, Mbegani; and Issack H. Tarimo, Muleba, as well as third-year students of FETA at Nyegezi Campus.

Lastly, FAO thanks the external reviewers for their valuable suggestions on the draft and the subsequent versions, especially Dr Hamady Diop, Head of Programme Natural Resource Governance, Food Security and Nutrition, New Partnership for Africa’s Development Agency, Mr Yahya I. Mgawe, CEO of FETA in the United Republic of Tanzania, and Gloria Loriente of FAO Fisheries and Aquaculture Department for her professional work in the layout design and publishing of this document.

Abbreviations and acronyms

ASEAN	Association of Southeast Asian Nations
AU	African Union
AUC	African Union Commission
B(a)P	benzo(a)pyrene
BMDL10	benchmark dose level
CABFIN	Improving Capacity Building in Rural Finance
CEO	Chief Executive Officer
CMATPHA	Women Fish Traders and Processors Cooperative of Abidjan
CNFTPA	Centre National de Formation des Techniciens des Pêches et de l'Aquaculture (Senegal)
CO	carbon monoxide
Code	Code of Conduct for Responsible Fisheries
CO ₂	carbon dioxide
CSIR	Council for Scientific and Industrial Research (Ghana)
EAA	ecosystem approach to aquaculture
EAC	East African Community
EAF	ecosystem approach to fisheries
EU	European Union
FAO	Food and Agriculture Organization of the United Nations
FETA	Fisheries Education and Training Agency (United Republic of Tanzania)
FMM	Multipartner Programme Support Mechanism (FAO)
FRI	Food Research Institute (Ghana)
FSN	food and nutrition security
FTT	FAO-Thiaroye processing technique
GHG	greenhouse gas
GHP	good hygienic practice
GMP	good manufacturing practice
HACCP	Hazard Analysis Critical Control Point
ICT	information and communication technology
IGA	income-generating activity
ILO	International Labour Organization
IUU	illegal, unreported and unregulated (fishing)
LKR	Sri Lankan rupee
MIRAH	Ministry of Animal and Fisheries Resources (Côte d'Ivoire)
MCS	monitoring, control and surveillance
MOE	margin of exposure
MoU	memorandum of understanding
MTE	metallic trace element
NEPAD	New Partnership for Africa's Development
NIOMR	Nigerian Institute of Oceanography and Marine Research
NORAD	Norwegian Agency for Development Cooperation
PAH	polycyclic aromatic hydrocarbon
PAH4	Sum of 4 PAHs
PAH8	Sum of 8 PAHs
PASA	Agriculture Sector Support Project (Togo)
PHFL	post-harvest fish losses

PHFLA	post-harvest fish loss assessment
PHL	post-harvest losses
PHLA	post-harvest loss assessment
PFRS	Policy Framework and Reform Strategy of Fisheries and Aquaculture in Africa
PO(s)	producer organization(s)
RASFF	Rapid Alert System for Food and Feed
REC	regional economic community
RFLP	Regional Fisheries Livelihoods Programme for South and Southeast Asia
SDDP	Support to District Development Programme (Sri Lanka)
SDG	Sustainable Development Goal
SFMP	Sustainable Fisheries Management Project (Ghana)
SFP	Strengthening Fishery Products Health Conditions in ACP/OCT Countries
SIDA	Swedish International Development Cooperation Agency
SNV	Stichting Nederlandse Vrijwilligers (Netherlands Development Organisation)
SPS	Sanitary and Phytosanitary Measures
SSA	sub-Saharan Africa
SSF	small-scale fisheries
SSF Guidelines	Voluntary Guidelines for Securing Sustainable Small-Scale Fisheries in the Context of Food Security and Poverty Eradication
SWOT	strengths, weaknesses, opportunities and threats
TCP	Technical cooperation programme (or project)
UFHB	Université Félix Houphouët-Boigny (Côte d'Ivoire)
UN	United Nations
UNIDO	United Nations Industrial Development Organization
UN Comtrade	United Nations Commodity Trade Statistics database
USAID	United States Agency for International Development Agency
USD	United States dollar
UTF	Unilateral Trust Fund
VETLAB	veterinary laboratories (network)
WAAPP	West Africa Agricultural Productivity Programme
WAEMU	West African Economic and Monetary Union (UEMOA in French)

Executive summary

The significance of fish smoking and drying in the tropics cannot be overemphasized. This pathway generates fish as food that makes up 12 percent of global fish utilization, of which more than 60 percent is produced in African and Asian developing countries. However, prevailing processing technologies present critical challenges, especially in terms of safety and quality aspects, and thus there is an urgent need for the development of more efficient and safer systems. Indeed, a global mapping commissioned in 2016 on a sample of ten countries among the largest producers of smoked and dried fish in Africa and Asia (Cameroon, Chad, Côte d'Ivoire, Ghana, India, Nigeria, the Philippines, Senegal, Sri Lanka and the United Republic of Tanzania) established the basis of an inventory of existing production systems and related enforced normative regulatory and institutional mechanisms. Findings showed that, although the Codex Alimentarius Code of Practice specific to polycyclic aromatic hydrocarbons (PAHs) was issued in 2009, these countries' preparedness or levels of implementation are inadequate. To date, most of them have not incorporated provisions on PAHs in their national regulations; moreover, the smoking systems used do not comply with the Codex Alimentarius Code of Practice. Only exporters to the market of the European Union meet the requirements based on that organization's standards, as they are compelled to comply in order to penetrate or remain in this remunerative outlet. This highlights significant shortcomings in terms of food safety, as more than 95 percent of the total volume of smoked and dried fish produced is sold on the domestic and regional markets where a high risk of PAHs occurrence is mirrored.

Improved smoking systems such as the FAO-Thiaroye processing technique (FTT) developed in mainstreaming the Codex guidelines have brought about substantial benefits and, in most instances, helped processors adopt them to comply with the requirements, thus contributing to countries' efforts to meet their foreign income earnings and food safety objectives. However, lessons learned from the field in several geographical contexts (African and Asian countries) suggest that some balance needs to be struck in relation to the overwhelming advantages and the potential contextual drawbacks (trade-offs) that may affect the adoption of these improved smoking systems.

This publication develops a thorough understanding of the multidimensional factors evolving around these smoking devices, based on studies in selected developing countries (Angola, Burkina Faso, Cameroon, Côte d'Ivoire, the Democratic Republic of the Congo, Ghana, Sri Lanka and the United Republic of Tanzania) with the second generation and a truly disruptive hot-smoking system, the FTT. It then devises policy recommendations with potential for application within and beyond the "study countries".

The findings of the case studies herein presented are:

- Hot-smoked fish is an important commodity supporting food and nutrition security and livelihoods for hundreds of millions of people in Africa and Asia.
- Traditional methods for fish smoking in the two continents compromise the safety of the product, have deleterious impacts on processors' health (of which the large majority are women), contribute to post-harvest losses, and detract from environmental sustainability efforts.

- The FTT has been demonstrated to be an efficacious alternative for fish smoking, guaranteeing the safety of products *vis-à-vis* PAHs and having strong potential to reduce post-harvest losses, secure processors' livelihoods, nurture decent working conditions for (women) fish processors, and support the greening of the smoked fish value chain. Regarding fish safety, which was the driver of the FTT's development, it should be underscored that this technique yields smoked products with PAH levels that are far lower than those in products from the preceding kilns. The main public health concern of PAHs lies in their potential to cause cancer. Risk assessments conducted suggest that the FTT significantly reduces consumers' risk of exposure to PAHs in smoked fish. Its margin of exposure is far beyond 10 000, indicating a minimal public health threat; hence, requiring no risk management actions as opposed to other hot-smoking kilns not equipped with this technology.
- Despite the identified benefits of the FTT, some factors need to be carefully considered within the limits of contextual characteristics to inform decisions and actions on its adoption and sustainable use. These are:
 - (i) upfront investment to acquire the kiln;
 - (ii) full adoption by processors intimately linked to several factors beyond the financial returns/sale price of FTT products, including, by rank of importance, the location of FTT kilns or their proximity *vis-à-vis* the owner's dwelling, the diligent / no-time-consuming operation and working environment;
 - (iii) suitable capacity with regard to raw material availability for full utilization of the kiln;
 - (iv) consumer acceptance of the products;
 - (v) premium pricing for products to accommodate value addition and sociocultural factors.

In light of the issues discussed, which clearly show that the superiority of the FTT over traditional systems for smoking fish is a necessary but not sufficient condition for the adoption of this new technology in order to reap the anticipated benefits, recommendations are made, highlighting the need for:

- clear policy objectives and pursuit of a longer-term strategy connected to a wide dissemination of the FTT consistent with sustainable use of the aquatic resources. Consequently, prior to locally promoting the dissemination and scaling-up of the FTT, countries must have a good understanding of the volume and health status of their fisheries resources and their capacity to produce eco-friendly and responsible aquaculture resources. This will ensure that the gains derived from the kiln are realized without compromising the sustainability of fisheries resources, and under no circumstances should the introduction of this technology foster illegal, unreported and unregulated fishing or drive overcapacity and its array of adverse consequences;
- a proper risk-based approach that informs policy and regulatory frameworks in standards setting, food safety regulations designing and enforcement, with implementation plans that support the development, piloting, adoption and sustainable use of improved fish smoking systems along with FTT products' proper benchmarking and differentiation;
- a participatory approach in the development, piloting and roll-out of improved smoking systems, one that is rolled out in a step-by-step fashion while explicitly capturing the inputs of the end users (processors and consumers);
- the development and proper management of appropriate infrastructure and the fostering of a culture of excellence and rewarding operators who enforce best practices;

- organizational and technical capacity development for processors with regard, but not limited to, tailored technical training on using and maintaining improved kilns, bookkeeping, establishing and managing cooperatives, entrepreneurial skills, safe and environmentally friendly packaging practices, and branding FTT products;
- sustained stakeholder education on the ills of traditional fish smoking methods and the benefits of improved systems in a language that highlights the gains of innovative kilns without damaging consumer confidence in smoked products;
- provision of access to financing and context-relevant savings instruments for processors while forging a shared responsibility in the acquisition of the technique, to discourage the dependency syndrome (which is not conducive for sustainable adoption);
- utilization of the full functions of the FTT, not only as a fish smoker but also as a mechanical dryer and as a tool for other value-added products, such as fish snacks, sausages, oils for further processing, etc., and opportunities for greening the value chains, with the introduction of biogas, solar and geothermal energy as a combustion source.

Chapter 1

Introduction

The global importance of fish and fishery products for food security and nutrition (FSN), foreign income earnings, and employment is steadily increasing. In terms of FSN, the share of world fish production utilized for direct human consumption has increased significantly in recent decades, up from 67 percent in the 1960s to 87 percent, or more than 146 million tonnes, in 2014 (FAO, 2018a). Besides being among the most widely traded commodities in the world, fishery products account for 17 percent of animal protein intake worldwide with per capita consumption in 2014 at 20 kg.

An overriding contribution to FSN goes beyond the protein intake, reflected by the increasing emphasis on the role of fish in providing long-chain omega-3 fatty acids and micronutrients such as vitamins and minerals, which are lacking in many local diets (Toppe *et al.*, 2012; Weichselbaum *et al.*, 2013). This is particularly true for fish eaten whole, which, in most cases are small pelagics (Thilsted *et al.*, 2014). In developing countries, especially in the tropics, fishery products' critical role in FSN, household livelihoods sustenance and socio-economic stability is well established. As an illustration, in 2014, 84 percent of the population engaged in this sector was in Asia, 10 percent in Africa and 4 percent in Latin America and the Caribbean. About 5.67 million people in Africa were engaged in capture fisheries and aquaculture in 2014 (FAO, 2016a). One study (de Graaf and Garibaldi, 2014) estimates that the fisheries sector as a whole employs 12.3 million people in Africa, half of whom are fishers, 42.4 percent are processors and 7.5 percent work in aquaculture. About 27.3 percent of people engaged in fisheries and aquaculture are women, of whom 58 percent are processors, 4 percent aquaculture workers and 3.6 percent fishers.

The per capita consumption in these regions, as the utilization form of fish, varies significantly. However, a key commonality is the essential measure applied to ensure that this fish reaches the consumer's table with minimal losses. Indeed, as fish is highly perishable and can spoil more rapidly than many other foods, it needs to be adequately handled, preserved and/or processed soon after being caught. Many methods are used for this purpose, of which a hot-smoking process that can produce the mainstay of products in many tropical countries tends to be the most popular one. However, it has been demonstrated (Ndiaye, Komivi and Diei-Ouadi, 2015) that the techniques used are not without several drawbacks, the most prominent being the potential for generating products with high levels of polycyclic aromatic hydrocarbons (PAHs). These PAHs may have a detrimental effect on human health at certain levels. The carcinogenic potential constitutes the critical effect for health hazard and risk characterization. Moreover, some of them have shown clear evidence of mutagenicity/genotoxicity in somatic cells (EFSA, 2008).

A global mapping commissioned by FAO in 2016 (Djessouho, 2018) reported that more than 60 percent of global smoked fish production originates in Africa and Asia. According to this study, which casts some light on the convincing scientific evidence regarding the extent of management of the connected food safety risk, the contribution of smoked fishery products from these regions could actually be more substantial than the present estimate. Study findings demonstrate that, although the Codex Alimentarius Code of Practice specific to PAHs (Code of Practice for the reduction of contamination of food with polycyclic aromatic hydrocarbons from

smoking and direct drying processes [CAC RCP 68-2009]) was issued in 2009, there are inadequacies in both the preparedness for, and levels of, its implementation in several countries. In most countries where hot-smoking of fish is practised, provisions on PAHs have not been incorporated in their respective national regulations and the smoking systems used do not comply with the Codex guidelines. Generally, only exporters of smoked fish to the market of the European Union meet the requirements based on that organization's standards, as they are compelled to comply in order to penetrate or remain in this remunerative outlet. This echoes significant shortcomings in terms of food safety, as more than 95 percent of the total volume of smoked and dried fish produced is sold on the domestic and regional markets; hence, a high risk of PAHs occurrence is mirrored. A proven contrast between the potential of smoked fish and the prevailing operations measures is thus evidenced, which undermines their sustainability and the benefits to be reaped from them. Given that the Codex Alimentarius is the global reference in food standards, guidelines and codes of practice for safety, quality and fairness of international food trade, it is unfortunate to note this overwhelmingly weak mainstreaming of the management of PAHs within the food safety objectives of major smoked and/or dried fish-producing countries.

The FAO flagship innovation, the dual fish smoking and drying system known as the FAO-Thiaroye processing technique (FTT) was developed in the aftermath of large market recalls and import bans as a result of perceived risks (e.g. smoked fish likely to exceed maximum limits of PAHs of European regulations) (Ndiaye and Diei-Ouadi, 2012). Its development inspired other subsequent initiatives, such as the emergence of the NIOMR kiln, a detachable FTT (Peñarubia, Randrianantoandro and Diei-Ouadi, 2018; Salaudeen, Osibona and Akande, 2018). Its promotion by development agencies is increasingly gaining momentum, with its presence in 16 countries over the past 5 years: Angola, Burkina Faso, Burundi, Cameroon, Côte d'Ivoire, the Democratic Republic of the Congo, Equatorial Guinea, the Gambia, Ghana, Guinea, Guinea-Bissau, Nigeria, Senegal, Sri Lanka, Togo and the United Republic of Tanzania, thus spanning from its native Africa continent to Asia, with Sri Lanka (Rotawewa and Wickramasinghe, 2018) as the first Asian country to have successfully experienced its piloting.

While these initiatives are taking place, lessons are being drawn that underscore the complexity around the adoption of a technology in the context of small-scale fisheries (SSF) and even within the same country, although it is recognized as an appropriate technology. They mirror potential threats if care is not taken to address identified detrimental factors. The feasibility study commissioned by FAO in 2016 (Mindjimba, 2017a) and deliberations during the fourth meeting of Professionals/Experts in support of Fish Safety, Technology and Marketing in Africa on "Benchmarking of smoking systems held in Elmina, Ghana from 14 to 16 November 2017 (Elmina meeting)", informed by lessons from operational case studies, casts some light on opportunities as well as threats and challenges pertaining to the successful and sustainable adoption of the FTT (Bomfeh *et al.*, 2018). Hence, there is an urgent need to address identified stumbling blocks to secure greater benefits from SSF. The meeting concluded that it is essential to align the fish smoking subsector with international standards and policies on the environment, decent work and consumer protection while safeguarding the value chain actors' assets. However, it also raised key issues that deserve critical attention, intimately linked to incentives for potential users to adopt innovative processing techniques for the benefit of the population at large, the environment and natural resources.

The present document discusses these developments, focusing on a reference tool in hot smoking of fish, the FTT, the first disruptive technology in this domain. It aims to enlighten policymakers, fisheries planners and decision makers and any development practitioner interested in developing SSF or promoting sustainable food systems, as well as private sector entrepreneurs who wish to implement this technology to

improve their products, following on the example of Côte d'Ivoire (see Chapter 8). It provides recommendations on how best to mainstream consumers' interests while supporting sustainable livelihoods interventions in fisheries communities. The aim is to contribute to the achievement of the 2030 Agenda for Sustainable Development Goals (SDG), especially but not exclusively SDG 12 "Ensure sustainable consumption and production patterns", SDG 14 "Conserve and sustainably use the oceans, seas and marine resources" and SDG 5 "Achieve gender equality and empower all women and girls", given the topical role of women in post-harvest fisheries. Apart from this introductory chapter, the document is divided into 9 chapters:

- Fisheries resources and supply pattern in selected countries;
- Advances in fish smoking systems: from traditional kilns to the FTT;
- Technical features of the specific components of the FTT;
- Comparative advantages of the FTT over traditional fish smoking systems;
- Benefits of the FTT;
- Trade-offs and challenges;
- Experience with regard to dissemination of the FTT across sub-Saharan Africa and Asia;
- Key policy-support elements arising from the FTT case studies;
- Conclusions and recommendations.

Chapter 2

Fisheries resources and supply pattern in selected countries

INTRODUCTION

The fisheries and aquaculture sector is a source of income and livelihoods for many millions of people in the world. According to FAO statistics, in 2012, more than 77 million people were employed in the sector globally. In 2008, about 135 million people were employed in the secondary sector, including post-harvest activities (FAO, 2012a). FAO does not collect data on the secondary sector from its Members. Nevertheless, case studies suggest that women may represent up to 30 percent of the total employment in fisheries, including primary and secondary activities. However, for all of these actors to continue to derive income and livelihoods from this sector and provide humanity with sufficient healthy fishery products, it is essential that issues of resource supply, loss reduction, environment conservation and sustainability duly feature within their priorities. Therefore, it is important to know the current status of fisheries resources for countries where the FTT has been introduced and for those contemplating doing so. This is the purpose of the present chapter.

RESOURCES – GLOBAL PICTURE

In 2014, dried, salted, smoked or other cured forms of fish for edible purposes represented about 12 percent (about 17 million tonnes) of total production (FAO, 2014, 2016a, 2017a). Figure 1 illustrates the importance of fish smoking and drying in the world.

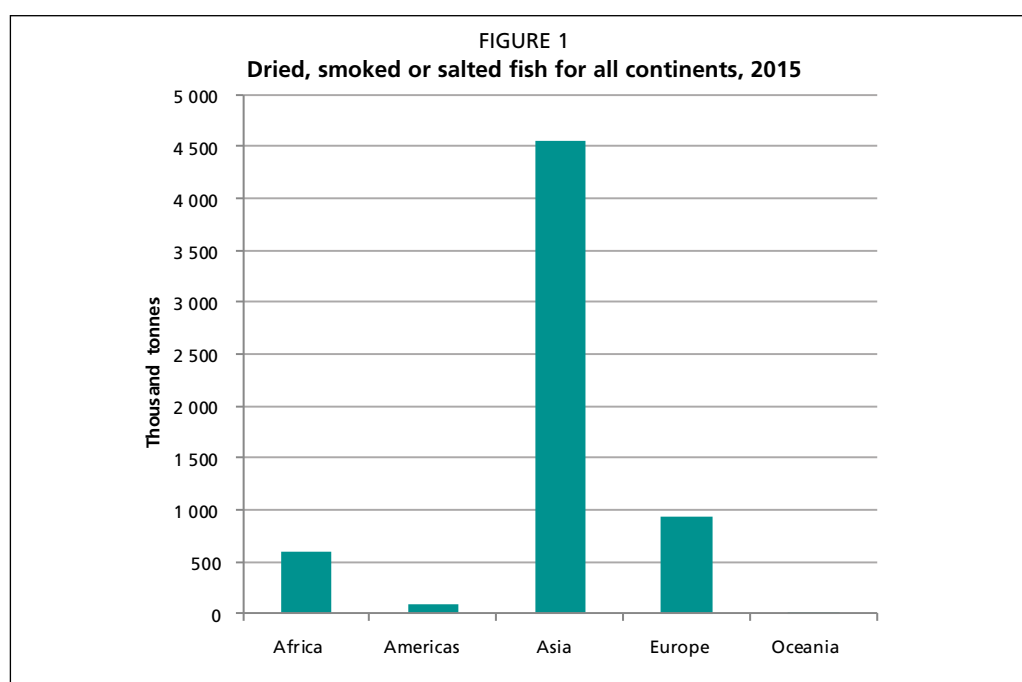

Source: FishStatJ, 2015 (FAO, 2017a).

Figure 1 shows that Europe has a higher production than Africa although most of the smoked fish is cold-smoked.¹ The focus of this document is thus on Africa and Asia, the two most important regions in terms of hot-smoked and dried fish production with 600 869 tonnes and 4 545 199 tonnes, respectively, representing 84 percent of total world production and with the highest hot-smoked / dried fish consumption per capita.

Several industrialized countries including Iceland and Norway export important quantities of dried fish to African countries such as Nigeria, and a number of European countries are important cold-smoked fish producers but exports of cold-smoked fishery products to Africa are negligible.

NATIONAL STATISTICS ON PRODUCTION, DRYING, SALTING AND SMOKING

This section includes data for countries having benefited from the FTT, others who are in the process of adopting it (see Chapter 8 for details on both of these) or those who could benefit from it. Figures in terms of recorded drying, salting and smoking activities for Angola, Benin, Burkina Faso, Burundi, Cameroon, Chad, Côte d'Ivoire, Equatorial Guinea, the Gambia, Ghana, Guinea, Kenya, Mozambique, Nigeria, Sao Tome and Principe, Senegal, Sierra Leone, Togo, Uganda and the United Republic of Tanzania, in Africa, and Cambodia, China, India, Indonesia, the Philippines, Sri Lanka, Thailand and Viet Nam, in Asia, are presented in this section as hot smoking and drying are among the main methods used in these countries for preserving fish.² Although total fisheries production figures are available for Burundi, Equatorial Guinea and Sao Tome and Principe, no data regarding drying, salting and smoking activities for these countries are available. The information gap for some countries presented in the section reflects the need to improve data collection and reporting for well-informed decision-making and for fostering the adoption of policy and regulations that address how to best disseminate the FTT.

Africa

Fish consumption per capita almost doubled in Africa between 1961 with 4.8 kg and 2011 with 10.4 kg (FAO, 2017b). Figures 2 and 3 illustrate the total fisheries production and the smoked/dried fish production in the selected African countries.

As shown in Table 1, large differences can be observed in the percentage of total fisheries production and processing volumes for the selected countries. However, the importance of these processing methods in the fish value chain is obvious and reveals that there is great consumer demand. It should be noted, however, that in some countries, the smoked fish found on local markets comes from imported frozen fish, as for example, in Angola, Benin, Côte d'Ivoire, Ghana and Togo, explaining the important quantities of imports.

¹ Most cold-smoked fish is dry-cured in salt for a certain number of days to draw out moisture. It is then smoked in temperatures below 26 °C. The cold smoke does not actually cook the fish, so it is left with an almost raw-like texture; hence, requiring a reliable cold chain.

² Fisheries data from the Democratic Republic of the Congo and the Lao People's Democratic Republic are not available on FishStatJ.

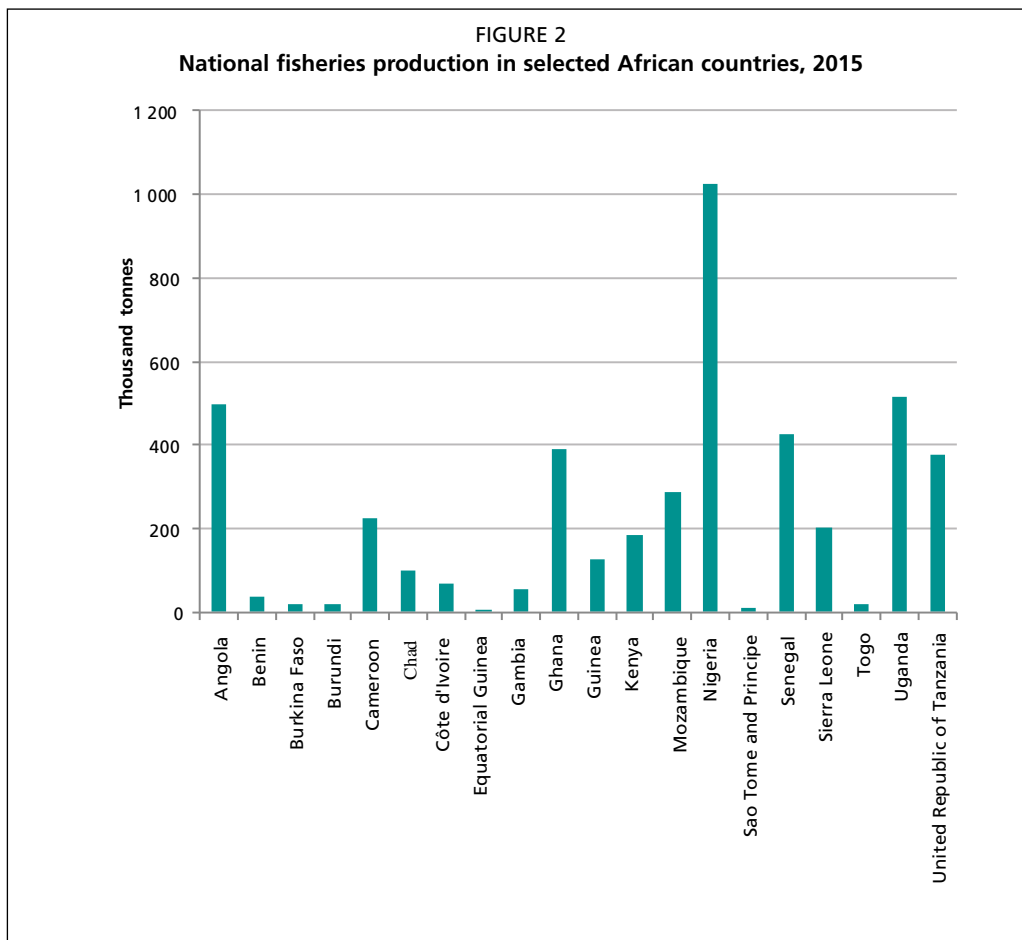

Source: FishStatJ, 2015 (FAO, 2017a).

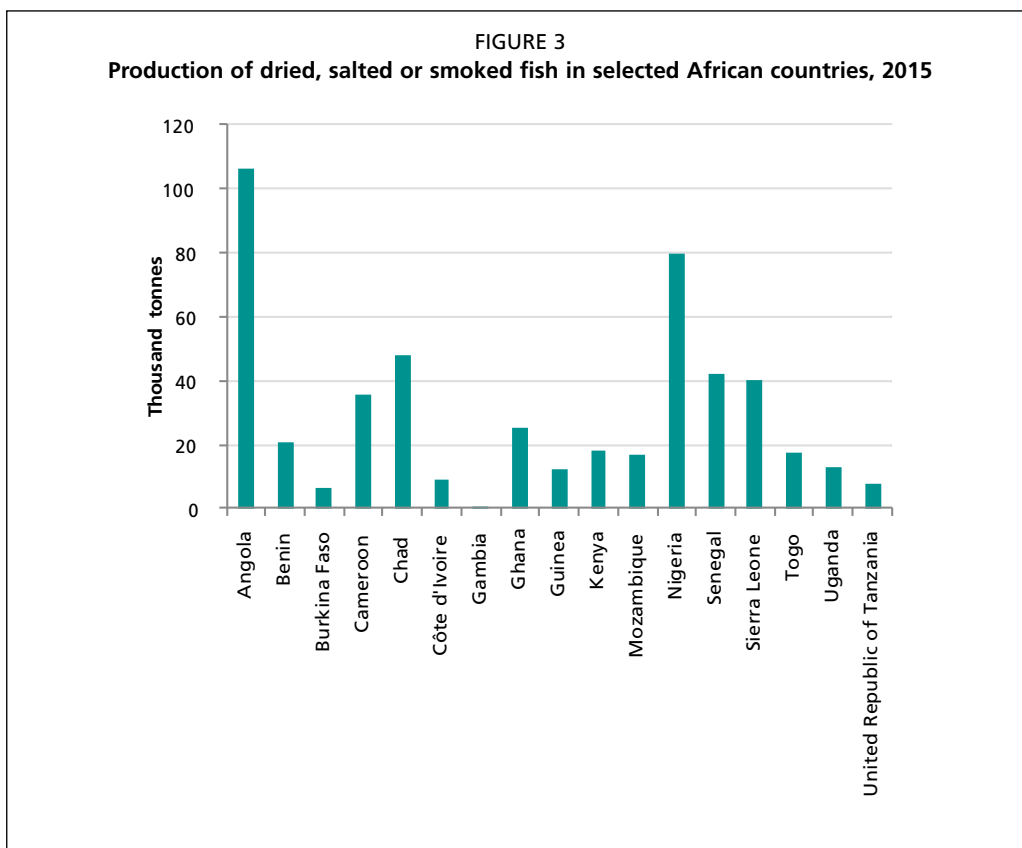

Source: FishStatJ, 2015 (FAO, 2017a).

TABLE 1
Percentage of total fisheries production that was processed in selected African countries in 2015

Country	Production	Dried, salted or smoked (Thousand tonnes)	Percentage
Angola	496	106	21
Benin	38	21	55
Burkina Faso	21	6	31
Cameroon	226	36	16
Chad	100	48	48
Côte d'Ivoire	68	9	13
Gambia	56	0.6	1
Ghana	391	25	7
Guinea	126	12	10
Kenya	184	18	10
Mozambique	288	17	6
Nigeria	1 027	80	8
Senegal	427	42	10
Sierra Leone	202	40	20
Togo	22	17	80
Uganda	514	13	3
United Republic of Tanzania	378	8	2
Total	4 564	499	
Average	269	29	11

Source: Compiled using FishStatJ 2015 data (FAO, 2017a).

The main processed-fish producers in terms of volume are Angola, Nigeria, Chad, Senegal, Sierra Leone and Cameroon. West African countries are more specialized than other countries in smoked fish. This illustrates not only fish consumption habits but the fact that, in countries where a well-performing cold chain has been almost non-existent, fresh fish may only be consumed by people living close to primary production centres who can purchase it within a few hours of it being caught.

No data are available on smoked/dried products consumption per capita. In terms of consumption habits, smoked/dried fish is generally consumed in sauces or soups, fried food, and vegetables, or accompanies braised products made from bananas, roots and tubers (cassava, yam, cocoyam, etc.).

In 2007, the West African Economic and Monetary Union (WAEMU), in the framework of the implementation of its agricultural policy, adopted the Plan for Joint Management of Fisheries and Aquaculture. This plan includes a regional programme for strengthening the collection of fishery statistical data and the creation of a regional database. In 2012, an extensive inland fisheries study was carried out and, in 2014, a similar exercise was undertaken for marine fisheries in coastal member countries. Figures 4–6 show how fish processing contributes to household revenues in the three WAEMU countries that are detailed in this section (Benin, Côte d'Ivoire and Senegal).³ Regarding marine fisheries, the study looked at first-rank and second-rank source of revenues.

³ These three countries were chosen because they have both marine and inland fisheries.

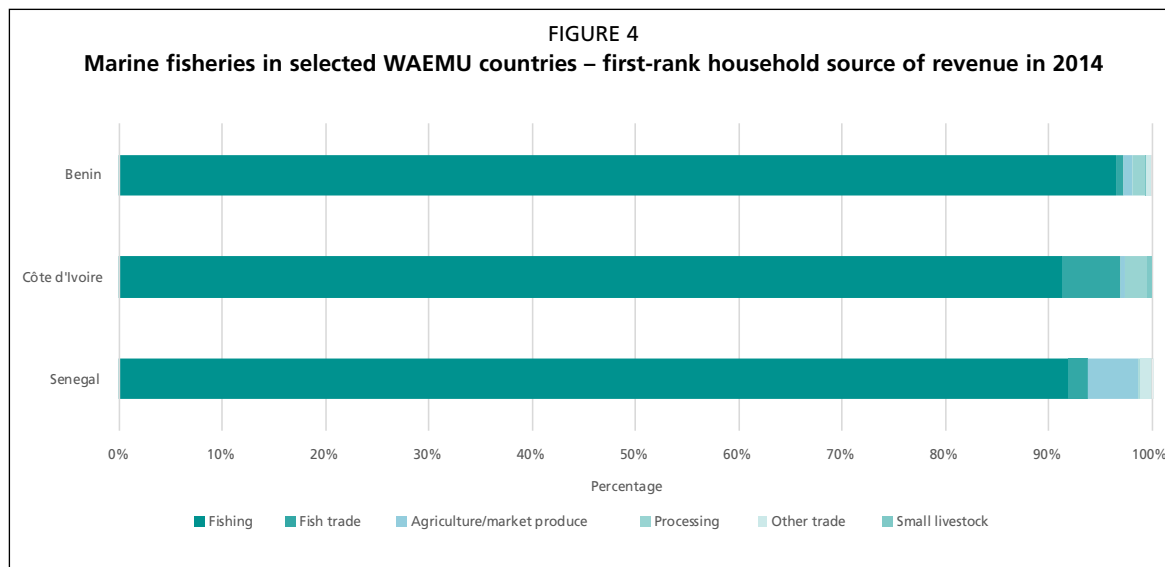

Source: WAEMU (2012–14).

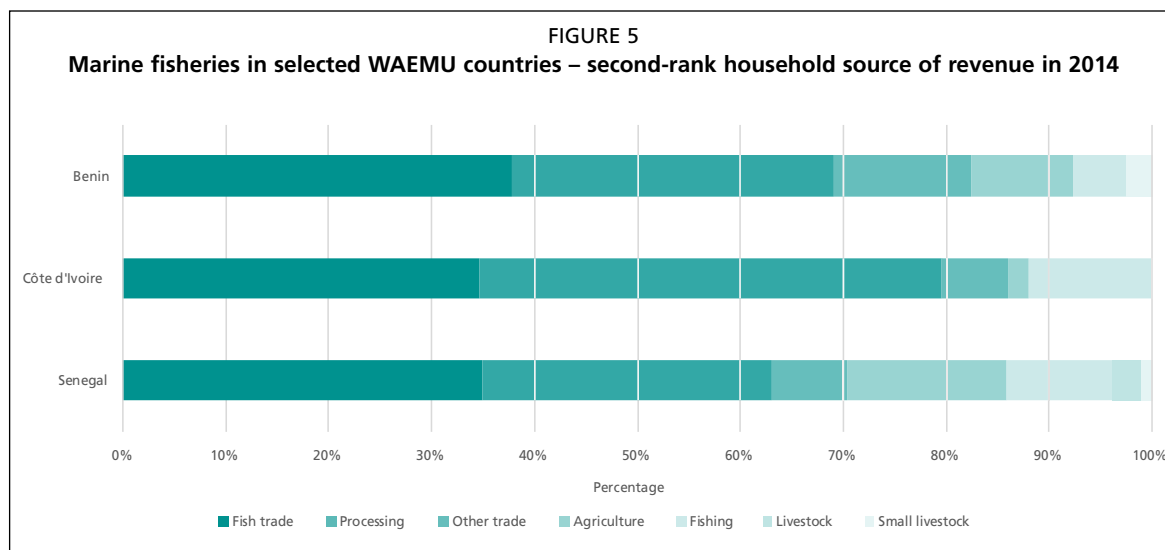

Source: WAEMU (2012–14).

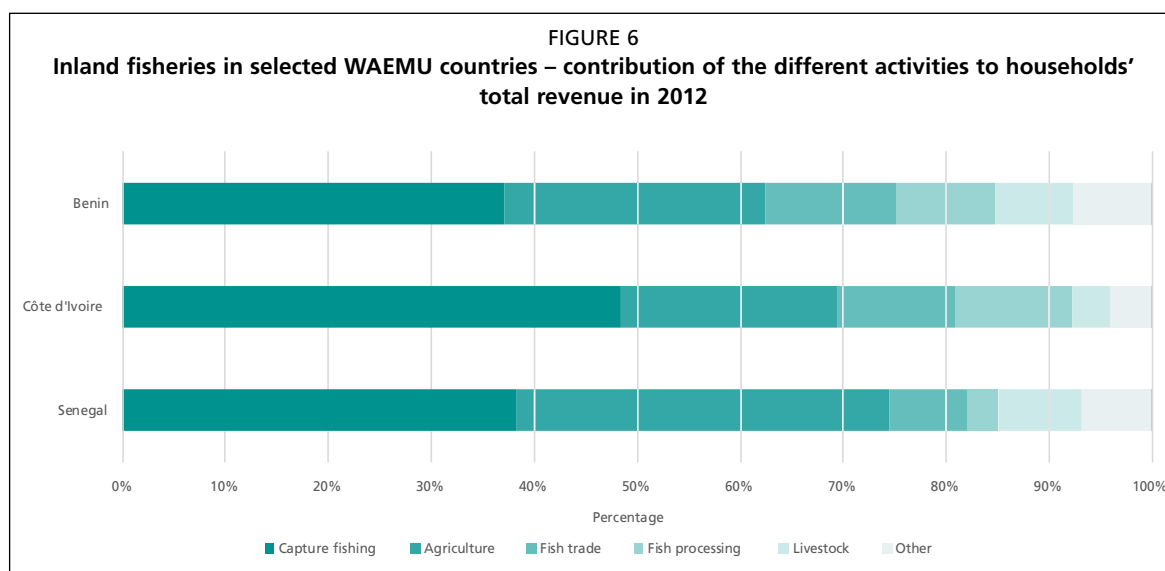

Source: WAEMU (2012–14).

Fishing, fish post-harvest and trade-related activities represent a crucial part of fisher households' revenue, be it in marine or inland fisheries. Although fish processing is almost never the first source of revenue for households, it does play a major role as a secondary financial source in marine fisheries in all three countries. Moreover, as women are usually solely responsible for fish processing but rarely for fishing in most households, this represents a large part of their income. In continental fisheries, it brings in 11.3, 9.6 and 3 percent of family earnings for Benin, Côte d'Ivoire and Senegal, respectively. This shows the importance of transforming this activity into a more efficient and profitable business venture. Moreover, the example of data for the three countries in Figures 4–6 may be considered an interesting illustration of variations from country to country, validating the need for preparatory studies that take into account local specificities to thoroughly understand the dynamics and needs of local fishing professionals.

Asia

Fish consumption per capita has tripled in Asia in the past five decades, up from 7.8 kg in 1961 to 23.2 kg in 2013 (FAO, 2017b). Drying is the most common technique in Asian production (Pradhan *et al.*, 2017), but smoking is also practised. Figures 7 and 8 present the total fisheries production and the smoked/dried fish production in the selected Asian countries.

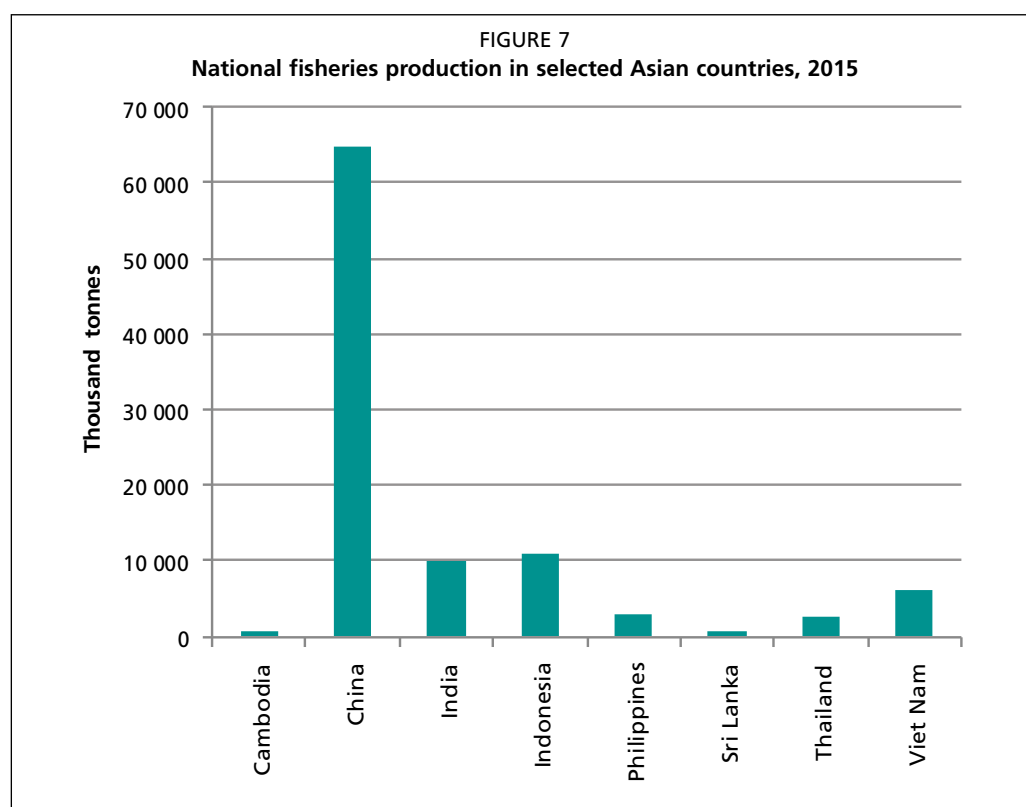

Source: FishStatJ, 2015 (FAO, 2017a).

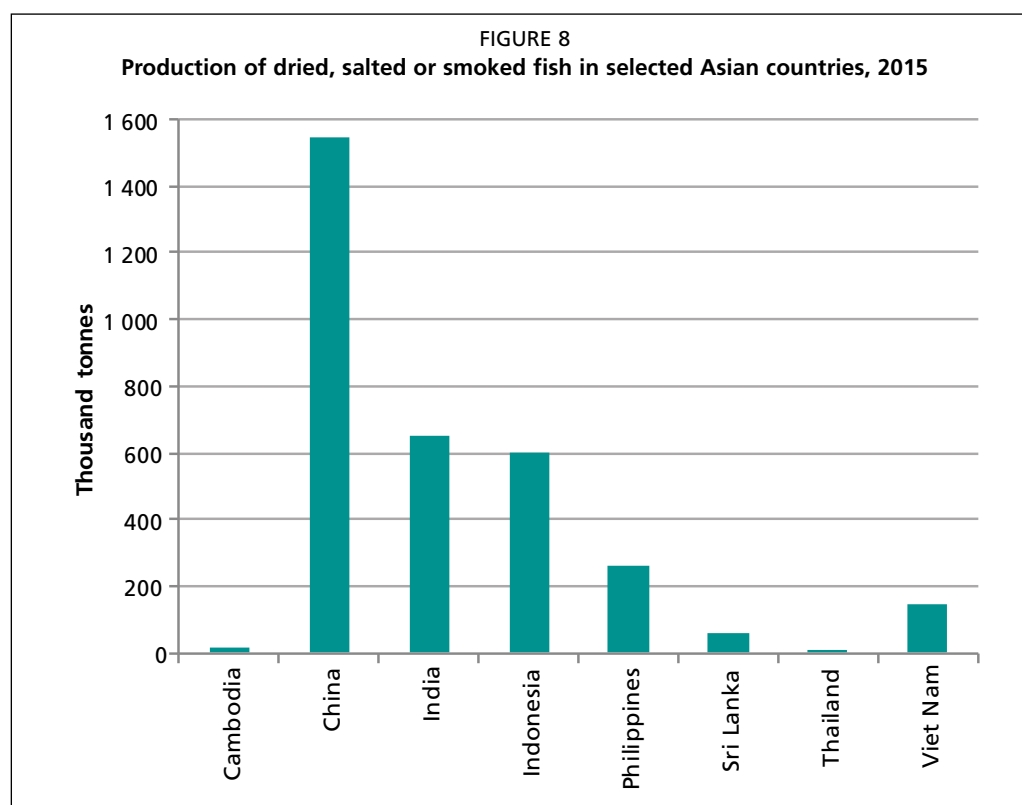

Source: FishStatJ, 2015 (FAO, 2017a)..

As shown in Table 2, differences in the percentage of total fisheries production and processing volumes for the selected countries are smaller than in Africa, with Sri Lanka and the Philippines having the highest percentage. However, fish volumes tend to be much larger, meaning that although drying, salting and smoking might make up a much smaller quantity of the total production, the volume of these processing methods are important along the fish value chain, showing that there is significant consumer demand.

TABLE 2

Percentage of total fisheries production that is processed in selected Asian countries in 2015

Country	Production	Dried, salted or smoked (Thousand tonnes)	Percentage
Cambodia	751	16	2
China	64 645	1 546	2
India	10 103	648	6
Indonesia	11 032	600	5
Philippines	2 933	264	9
Sri Lanka	532	57	11
Thailand	24 250	7	0
Viet Nam	6 197	144	2
Total	120 443	3 282	
Average	15 055	410	5

Source: Compiled using FishStatJ 2015 data.

Fish is also fermented in countries such as Thailand and Viet Nam, where different types of fish sauces are very popular. Although data on smoked/dried products

consumption per capita are not available, there is evidence that Asian consumers eat smoked and dried fish.⁴

TRADE STATISTICS

According to the United Nations Commodity Trade Statistics database (UN Comtrade), 21 out of the 25 countries selected for this study officially export cured, smoked or meal fishery products (Table 3). Many countries export and import this commodity, as in the case of Benin, where imports – more than 29 tonnes for a value of USD 303 936 – are much higher than exports. Figures for Burkina Faso, Chad and Uganda are not reported, while Nigeria imported 12 420 tonnes worth almost USD 138.3 million in 2016. Figures could be quite low for countries such as Benin, Côte d'Ivoire and Ghana, given that there is a lot of informal trade in SSF. Moreover, a high volume of informal trade can be observed all along the coast of West Africa and, hence, not recorded. Some countries that not only export cured, smoked or meal fishery products but also import them seem not to have communicated data to UN Comtrade, as shown, for example by Thailand reporting more than 17 555 tonnes exported to China. This makes it quite challenging to rely on these data to truly understand production and consumption of dried and smoked products, therefore calling for ad hoc studies when considering disseminating the FTT.

CONCLUSION AND WAY FORWARD

The data presented in this chapter show that there are large differences in terms of fisheries supplies and utilization between countries, be it in Africa or Asia, and that a careful assessment of each context is necessary to determine how, where and to what extent the FTT should be disseminated. In certain contexts, such as Benin, Cambodia, Côte d'Ivoire, Ghana, Nigeria and Togo, with something of a deficit in terms of fisheries production, the FTT should replace existing drying and smoking devices with a view to improving the working conditions for processors, reducing post-harvest fish losses (PHFL) and providing safer fishery products to consumers. Very careful attention should be given to potential negative effects that would stem from increasing the present drying and smoking capacity and volumes, as these may further weigh on the trade balance and exacerbate unsustainable resource management, be it in terms of product raw material or of fuelwood. Even if eco-friendly and responsible aquaculture production greatly expands, frozen fish imports should be reduced, so as to reduce the balance of payments deficit.

In other contexts where fisheries resources are still relatively abundant and the assessment shows an important volume of PHFL, dire working conditions for fish processors or poor processing techniques, disseminating the FTT should be widely promoted, as it is a very efficient tool to address all three of these issues.

⁴ See, for example: EastJava.com (2010), Lucy (2016) and Turow (2011).

TABLE 3
UN Comtrade world export figures of cured, smoked or meal fishery products

Country	Exports		Imports		
	Year	Volume (tonnes)	Value (USD)	Volume (tonnes)	Value (USD)
Angola	2015	n.a.	n.a.	11 094	2 778 373
Benin	2016	2	4 275	29	303 936
Burundi	2016	90	100	2 755	1 613 532
Burkina Faso			Not listed on UN Comtrade		
Cambodia	2016	3	10 900	3	8 179
Cameroon	2016	88	54 903	32	168 133
Chad			Not listed on UN Comtrade		
China (excluding China, Hong Kong SAR and China, Macao SAR)	2016	78 593	485 958 556	n.a.	n.a.
Côte d'Ivoire	2015	190	163 310	74	689 978
Gambia	2016	1 603	758 838	106	68 478
Ghana	2016	14	23 540	3 506	3 172 569
Guinea	2015	140	402 268	22	1 681 403
India	2016	7 550	70 518 410	n.a.	n.a.
Indonesia	2016	13 823	62 188 344	n.a.	n.a.
Kenya	2013	1 116	555 172	17	67 445
Mozambique	2016	4 257 495	2 373 648	44	313 395
Nigeria	2016	n.a.	n.a.	12 424	138 260 768
Philippines	2016	4 227	16 871 062	194	706 752
Senegal	2016	3 366	4 651 054	n.a.	n.a.
Sierra Leone	2016	59	15 165	n.a.	n.a.
Sri Lanka	2016	343	3 845 372	n.a.	n.a.
Thailand	2016	57 173	104 888 604	n.a.	n.a.
Togo	2016	n.a.	n.a.	1 734	467 824
Uganda			Not listed on UN Comtrade		
United Republic of Tanzania		6 391	10 174 901	12 628	48
Viet Nam	2016	n.a.	110 085 843	n.a.	n.a.

n.a. = not available.

Source: UN Comtrade database accessed 5 June 2018.

Chapter 3

Advances in fish smoking systems: from traditional kilns to the FTT

INTRODUCTION

An article published in the INFOFISH series following the first experience in shifting from traditional kilns to the FTT system in SSF (Diei-Ouadi and Sodoke, 2013) and a comprehensive background paper prepared by Peñarubia, Randrianantoandro and Diei-Ouadi (2018) for the Elmina meeting did a stocktaking of existing smoking devices. The latter elaborated on research efforts that had taken place in the past two decades, and provided some food for thought on typical kilns and future research areas in enhancing fish smoking in Africa, keeping in mind a three-pronged objective: (i) fish safety; (ii) decent work (occupational health and safety, economic viability); and (iii) environmental protection for sustainable fish food systems development. The present chapter reviews these issues, which are further detailed in subsequent chapters. It first traces the historical background of the first generation of improved fish smoking systems, discussing their effectiveness in addressing some of the problems associated with the prevailing traditional smoking systems as well as deficiencies in some others, especially smoked fish safety. Then, the chapter explains the driving force towards the development of the second generation of improved kilns, i.e. the FTT, its design and introduction in a number of countries in sub-Saharan Africa (SSA) and in Asia.

EMERGENCE OF THE FIRST GENERATION OF IMPROVED KILNS TO ADDRESS CRITICAL INEFFICIENCIES IN TRADITIONAL SMOKING SYSTEMS: THE ERA OF THE CHORKOR SMOKER

Both above-mentioned documents acknowledged the existence and use of different smoking devices that present significant deficiencies in most of their design and operations. Until late 2005, the Chorkor kiln, a fruit of collaborative research in 1969 between FAO and the Food Research Institute (FRI) of the Council for Scientific and Industrial Research (CSIR) of Ghana, was the reference technology in addressing the key shortcomings of traditional smoking stoves. These traditional ovens span from the simplest type, using a mud or rush hut in which the fish are placed on rocks above the fire (Figures 9 and 11), to a drum with an open fire above which the fish are laid on a mesh or grill (Figure 10).

The Chorkor smoker (Figure 12) was effective in addressing fuel efficiency, yield, organoleptic quality and holding capacity, but critical concerns such as the smoky working environment and exposure of women fish smokers to health hazards, including burns and too much heat, remained (Randrianantoandro and Diei-Ouadi, 2015).

These concerns were important enough to draw attention and drive development institutions to further improve that smoking system.

FIGURE 9
Rush hut stove in the Democratic
Republic of the Congo



© FAO/Guy Bungubetshi

FIGURE 10
Drum-type stove in Ghana



© FAO/Kennedy Bomfeh

FIGURE 11
Mud stove / traditional Dafing in Burkina Faso



© FAO/Yacouba Ouedraogo

FIGURE 12
Chorkor kilns in Ghana



© FAO/Kennedy Bomfeh

MEETING SPECIFIC SOCIOCULTURAL NEEDS WITHIN THE OPERATIONAL CONTEXT OF THE CHORKOR KILN

Over the years of its active promotion, experience showed challenges linked to having the Chorkor smoking kiln accepted socially in some fisheries communities, especially in West Africa (Chabi *et al.*, 2014). The problem lay in the deep-rooted practice of single rather than multiple trays in the Chorkor or the laborious stacking order changing of the trays during the smoking process. This marked the emergence of the Banda oven from Senegal and the Altona, which is an adaptation from existing devices in the United Kingdom of Great Britain and Northern Ireland, and in major fishing nations such as the Gambia, Senegal and Sierra Leone (Figures 13–16).

This new generation of improved kilns (Chorkor, Banda and Altona) was actively promoted until a time when advances in science called for further improvement in good smoking practices (Peñarubia, Randrianantoandro and Diei-Ouadi, 2018). The challenges to overcome were significant enough to warrant critical attention, as they undermined smallholders' opportunities to reap greater benefits from their operations, and so contribute more effectively to food security, national economic development through domestic marketing, foreign income, various levies and ancillary employment (Diei-Ouadi and Sodoke, 2013).

FIGURE 13
Banda oven in Burundi



© FAO/Oumoulkhairy Ndiaye

FIGURE 14
Hybrid Banda in Burundi



© FAO/Oumoulkhairy Ndiaye

FIGURE 15
Altona oven in Burundi



© FAO/Oumoulkhairy Ndiaye

FIGURE 16
Detachable and portable single compartment
Banda for flood-prone areas in the Congo



© FAO/Yvette Diei-Ouadi

NEW SCIENTIFIC EVIDENCE AND MARKET-ACCESS-DRIVEN DEVELOPMENT OF THE SECOND GENERATION OF IMPROVED KILNS: DEVELOPMENT OF THE FTT

The market of the European Union is known as a particular niche for the export-oriented operators that send some of their smoked and dried fishery products to meet the demand of the African diaspora. As some African countries that traditionally exported products to this market (such as Côte d'Ivoire and Ghana in West Africa) started experiencing alert notifications and rejections of their smoked fish in 2004, the region's awareness of the need for an improved tool surged. The interest was to help curb benzo(a)pyrene (B[a]P) limits – which was at that time the only emerging chemical food safety hazard, and considered to be the sole marker for the occurrence and carcinogenic effect of PAHs – so as to find a way to resume exports of this commodity (Peñarubia, Randrianantoandro and Diei-Ouadi, 2018). As an illustration, Côte d'Ivoire lost USD 1.6 million between 2006 and 2011 following a self-imposed ban on exports following the critical alerts; PAHs were the main causes of rapid alerts of fishery products exported from Ghana (46 percent of the total of Ghana alerts) between 2004 and 2014 (Diei-Ouadi, Randrianantoandro and Ndiaye, 2017).

Over time, there has been growing attention within the regulatory frameworks of the European Union (Member Organization), first on B(a)P. Up to a certain date, only B(a)P was identified as a marker of occurrence and effect of the carcinogenic

PAHs in food, justifying that organization's setting of a minimum acceptance level of B(a)P, which is 5 µg/kg in smoked and dried fish. However, a review by a European Food Safety Authority scientific panel in 2008 concluded that B(a)P is not a suitable indicator for the occurrence of PAHs in food. It stated that, based on available data on occurrence and toxicity, PAH4 (benzo[a]pyrene, benzo[a]anthracene, chrysene and benzo[b]fluoranthene) and PAH8 (benzo[a]pyrene, benzo[a]anthracene, benzo[b]fluoranthene, benzo[k]fluoranthene, benzo[ghi]perylene, chrysene, dibenz[a,h]anthracene and indeno[1,2,3-cd]pyrene) are the most suitable indicators of PAHs in food, with PAH8 not providing much added value compared with PAH4 (EFSA, 2008). This was the rationale for amending previous regulations, with new provisions effective from 1 September 2012. For these, the single B(a)P level must meet the 5 µg/kg requirement, but also the sum of PAH4 must not exceed 30 µg/kg. Since 1 September 2014, the B(a)P requirement has been further reduced to 2 µg/kg while the allowable sum of PAH4 is no more than 12 µg/kg (Commission Regulation 835/2011 of 19 August 2011) (European Union, 2011).

It is against this backdrop, which, in 2005, already mirrored a worsening scenario for the fish smoking industry in Africa, that FAO took the lead in a collaborative investigation with fisheries institutions within the framework of the African Network in Fish Technology Safety and Quality (Diei-Ouadi, Randrianantoandro and Ndiaye, 2017). This was at the time when the first FAO workshop on fish technology, utilization and quality assurance in Africa (actually the eighth in the series if the term "expert consultation" was still applicable) was being prepared to then take place in Bagamoyo, the United Republic of Tanzania (FAO, 2007). Technology development centred on addressing this common challenge of PAH control featured on the agenda of the Bagamoyo meeting in 2005 and was a recurrent agenda item until 2011 (FAO, 2009a, FAO, 2012b).

During the meeting in the United Republic of Tanzania, the AFSMO-150 prototype (Figure 17), an improved fish smoking oven developed by the FRI was presented (Blay and Atikpo, 2007). This was the first attempt to reduce PAHs in smoked fish. However, incomplete combustion and fat pyrolysis in the system did not allow sufficient reduction of the hazard. In the following session in Agadir, Morocco, in 2008 (FAO, 2009a), the Institut de Recherche Technologique of Gabon presented a sketch of the so-called Bidul kiln (Ekomy, 2008). The products were well accepted on the Gabonese market; however, the technique needed improvements for consistency in the products in terms of PAH limits and its user-friendliness. At that meeting, an industrial fish smoking with focus on the control of PAHs (Sérot et al., 2009) was also presented. Recommendations were therefore formulated to interested researchers for work to further improve the small-scale fish-smoking processes. This marked the post-Agadir meeting era of the FAO engagement in a collaborative framework with the Centre National de Formation des Techniciens des Pêches et de l'Aquaculture (CNFTPA) in Senegal to design a process building on existing facilities. At that time, deliberations within Codex Alimentarius meetings were well advanced regarding the content elements of a code

FIGURE 17
AFSMO-150 improved fish smoking kiln in a fishing village near Accra, Ghana



© FAO/Yahya Mgawe

of practice, which was then officially published in 2009 (CAC/RCP 68-2009 [CAC, 2009]).

Under FAO technical advisory services, inspired by the Codex code of practice and capitalizing on lessons learned from past trials, the CNFTPA developed a preliminary sketch of a smoking kiln with devices tested successfully in 2010 with export-oriented / medium-scale fish processing units in Togo within a programme funded by the European Union (Member Organization) (SFP Info, 2010). The idea of also using the system as a mechanical dryer arose during subsequent pilot tests. This brought great hope for a new beginning in the sustainable development of these processing operations. Indeed, it was swiftly adopted as it enabled the resumption of exports to the lucrative market of the European Union, giving it a characteristic of a market-access-driven tool. In fact, the adoption of the first prototype piloted, and subsequent re-inclusion of previously banned medium-scale processing units on the national competent authority list of establishments approved by the European Union (Member Organization) reflected a clear sign of restored confidence (Diei-Ouadi, Randrianantoandro and Ndiaye, 2017). Thus, the experience, and the lesson learned, from this process is that stringent regulations coupled with consistent enforcement measures (e.g. rejections, bans) by a rewarding market (that of the European Union) have been the driving force towards adoption of a good practice by processors and the private sector.

During the third Expert Workshop on Fish Technology, Utilization and Quality Assurance in Africa held in Mahe, Seychelles on 22–25 November 2011, the FTT was validated as the first disrupting fish technology proven to drastically minimize PAH levels (FAO, 2012b). However, the enacting of EC 835/2011 and later EC 2015/1125, which both amended EC 1881/2006, resulted in much stricter regulation of PAH levels in food products. This led to recommendations by the experts for further product analyses beyond the B(a)P, extended to the foreseen PAH4. The recommended analyses were completed positively before the FTT was first introduced in 2013 in SSF within the framework of a regional capacity development workshop organized by FAO in Abidjan, Côte d'Ivoire. Through the SmartFish Programme in 2013, the technology was introduced to Eastern and Southern African countries, including the United Republic of Tanzania. In 2014, FAO, in collaboration with SNV Netherlands Development Organisation, introduced it in Ghana.

FIGURE 18
Launch of the FTT in Ghana



© FAO/Yvette Diei-Ouadi

FIGURE 19
A typical FTT-Dafing in Burkina Faso



© FAO/Oumoulkhairy Ndiaye

The square-shaped FTT is well known, but other shapes have emerged, such as the so-called FTT-Dafing in Burkina Faso, in response to the customization of the FTT to the sociocultural context, essential to its adoption. The development of this smaller round kiln and its adoption were entirely driven by the beneficiary women fish processors within the framework of the FAO's Multipartner Programme Support Mechanism (FMM) project Enable Women to Benefit More Equally from Agri-food Value Chains (FMM/GLO/103/MUL), implemented in 2016–17 in the Sourou fish production area. Figures 18 and 19 show different kilns equipped with the FTT technology.

CONCLUSION

The FTT is the fruit of five years of design improvements, trials, sensory evaluation, laboratory tests, networking and target users' assessments at different geographical locations, concluded with the CNFTPA (Diei-Ouadi, Randrianantoandro and Ndiaye, 2017). It builds on the strengths of the first generation of improved kilns (Chorkor, Banda, Altona, whether removable or not), while addressing challenges linked to PAHs and other weaknesses, such as the negative environmental and social impacts, and the possibility for multitasking during smoking.

Chapter 4

Technical features of the specific components of the FTT

INTRODUCTION

This chapter provides an overview of the technical features of the specific components of the FTT. The step-by-step construction procedure of this new system is described in relevant technical documents such as the methodological manual produced by Ndiaye, Komivi and Diei-Ouadi (2015). This chapter first recalls how the FTT addresses the PAH problem, which was the driver of its development. It then presents an illustrated FTT prototype customized to the local environment to meet specific sociocultural needs.

THE FTT AND THE PROBLEM OF POLYCYCLIC AROMATIC HYDROCARBONS (PAHS)

The Code of Practice issued by the Codex Alimentarius Commission (CAC/RCP 68-2009 [CAC, 2009]) (Ndiaye and Diei-Ouadi, 2009) highlighted that the formation of PAHs during smoking and direct drying is dependent on a number of variables, including:

- fuel (wood and other plant materials, diesel, gases, liquid or solid waste and other fuels);
- smoking or drying method;
- smoke generation process in relation to the temperature of pyrolysis and to airflow in the case of a smoke generator or in relation to other methods, such as direct smoking or regenerated smoke by atomizing smoke condensate;
- distance between the food and the heat source;
- position of the food in relation to the heat source;
- fat content of the food and what happens to the fat during processing;
- duration of smoking and direct drying;
- temperature during smoking and direct drying;
- cleanliness and maintenance of equipment;
- design of the smoking chamber and the equipment used for smoke–air mixture.

The technical features of the FTT mainstream these guidelines, adding three main components on existing improved fish smoking systems such as the Chorkor, Banda and Altona kilns (Ndiaye and Diei-Ouadi, 2012). The additional components are:

- a container for embers (inserted in part a on Figure 20) that holds the energy source for heating the fish placed in the smoking or drying trays, thus minimizing the heat leakage, besides its easing the stowage and handling of materials (heat-retention stones, charcoal, agricultural by-products, etc.);
- a fat-collection tray (part b): a metal sheet with raised cones placed between the fish on the racks and the heat source, in order to prevent the dripping from the fish from falling onto the fire which could generate tar deposits. As detailed in Chapter 6, this is the most potent component in terms of controlling the occurrence of PAHs when smoking fatty fish;

- an external smoke generator (part c), which contributes to cooling the smoke and retaining harmful materials through a humid phase or humidified food grade sponge.

Overall, the key operational features associated with these components can be summarized as follows:

- separation of the cooking and smoking processes;
- complete combustion of fuel;
- prevention of fat dripping unto heat source (fat drains from a tray into an external receptacle for further use);
- indirect smoke flavouring and filtration of smoke for same purpose.

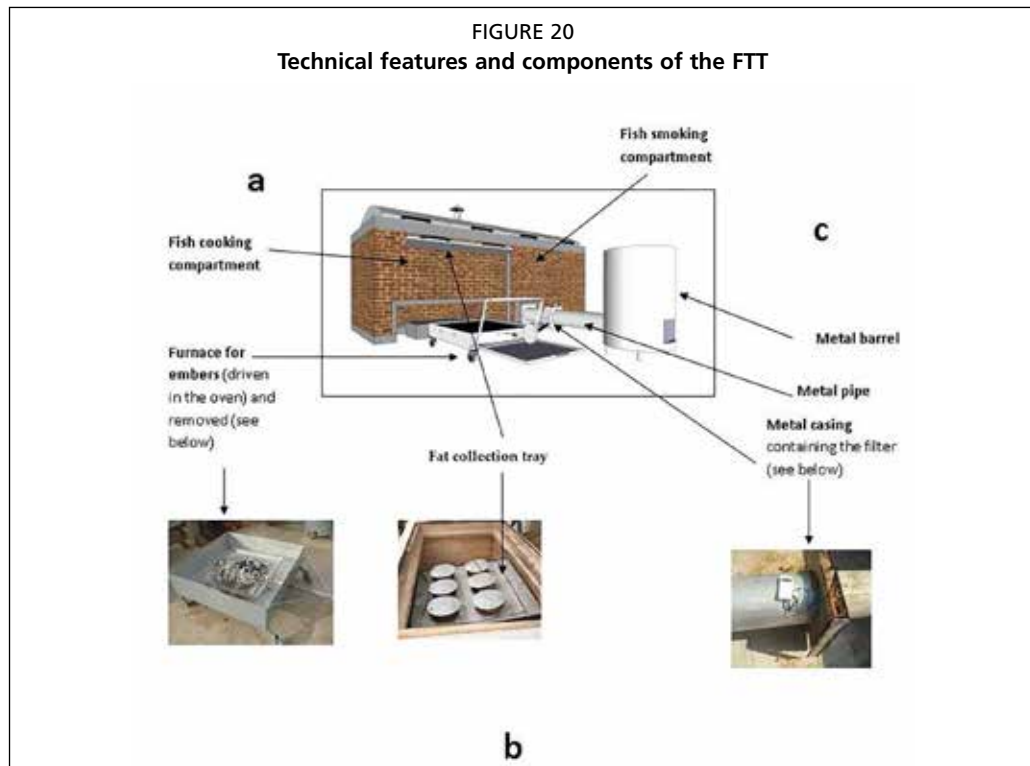

© FAO/Oumoulkhairy Ndiaye

With the use of this technology, the B(a)P level of the smoked fishery products is well below 0.50 µg/kg, at least 10 times less than the requirements of the standards of the European Union. There is also greater fuel efficiency than in the first generation of improved kilns (Chorkor, Banda, etc.) as a result of controlled heat leakage and the heat-retention stones used. As an illustration, there is 33 percent less fuel consumed than in the Chorkor for a hard-smoking process (Peñarubia, Randrianantoandro and Diei-Ouadi, 2018).

As further detailed in Chapter 6, the possibility to process by-products such as oil collected from fat-collection trays is another added value of this innovation.

THE FTT-DAFING

As introduced in Chapter 3, the FTT-Dafing is a model that builds on the operational principle of the FTT, within a given sociocultural context in SSF, notably in Burkina Faso. It is the fruit of an actively participatory design process between women potential users and the FTT engineer during the implementation of an FMM project. While the holding capacity is smaller than the square-shaped (original/common) FTT, the FTT-Dafing (Figure 21) incorporates in its tray's frame a pot/jar, which has a historical usage for women processors.

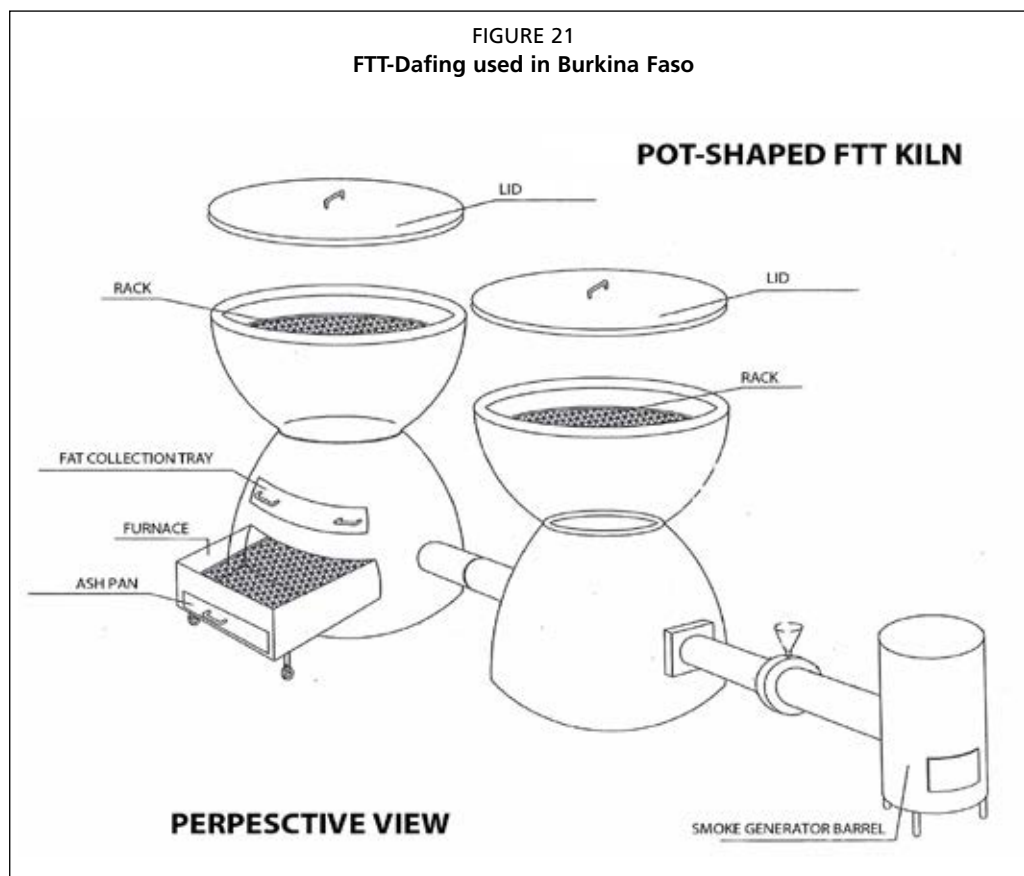

© FAO/Oumoukhairy Ndiaye

CONCLUSION

While the original square-shaped FTT and the technical features of its specific components are well documented to the extent that this new system is being piloted in a number of SSF across SSA and Asia (see Chapter 8 for details), experience shows that other shapes can also be customized to the local environment to meet specific sociocultural needs. The round-shaped FTT-Dafing used in Burkina Faso is an illustrative prototype in this regard.

Chapter 5

Comparative advantages of the FTT over traditional fish smoking systems

INTRODUCTION

This chapter compares the strengths, weaknesses, opportunities and threats (SWOT) of the FTT and traditional fish smoking systems. The chapter first compares the two systems with regard to different criteria. It then compares their respective SWOT. The benefits of this innovation are reviewed in Chapter 6.

COMPARING THE FTT WITH TRADITIONAL FISH SMOKING SYSTEMS

The FTT and traditional fish smoking systems are compared with regard to five main criteria: technical; safety and quality of end products; environmental; social and public health; and financial and economic. These criteria are summarized below inasmuch as most of them are detailed in Chapter 6.

Technical criteria

- As described in Chapters 3 and 4, by design, the FTT consists of improved existing fish-smoking kiln prototypes (Banda, Chorkor and Altona). It builds on their strengths while correcting their deficiencies, notably by adding new components, all of which can be made locally and incorporated into the existing traditional kilns, and dimensioned and moulded to local needs.
- On another note, traditional systems are rudimentary by design; typical examples are cut-up barrels and metal drums, clay and mud kilns, and the traditional Banda.
- FTT kilns are generally housed under a shed (Ndiaye, Komivi and Diei-Ouadi, 2015) or a platform, while traditional kilns are installed in a rudimentary smokehouse or in the open air (dryers in particular, thus exposing the fish to the inclemency of weather and contamination by insects, rodents, bird droppings, airborne particles, wood dust, etc.).
- The FTT shortens the processing time, i.e. by 2–4 times compared with the Chorkor, and up to 10 times compared with traditional metal-drum kilns.
- Smoking with the FTT is indirect, whereas with the traditional systems it is direct.
- In contrast to the traditional fish processing systems, the FTT allows processors to:
 - control the flames and smoke, thus minimizing the risk of fire and health hazards;
 - protect the fish against contamination thanks to its components (which are covered).
- Fish processing with the FTT and other improved systems is separate (cooking or smoking is separate from drying), whereas with the traditional systems it is simultaneous.

- Unlike the traditional systems, with the FTT, fish processing can be performed in all seasons regardless of weather conditions.

Safety and quality of end products

- As detailed in Chapter 6, FTT products have lower PAH levels and are therefore safer.
- With regard to quality (Figure 22):
 - FTT products have a golden colour, shiny and uniform in appearance, while those resulting from the Chorkor are dark brown in colour with a loosely adherent skin, and those from the traditional cut-up drums are blackish, with loosely adherent skin and inconsistent appearance;
 - the texture of FTT products is firm, while that of the other systems is generally hard;
 - FTT products have a pleasant taste, whereas products derived from the other systems are generally bitter because of the presence of PAHs and tar particles;
 - the smell of FTT products is characteristically good compared with that of the other systems;
 - the shelf-life of FTT products is comparatively longer (up to 5–6 months), thereby improving their marketability.



Environmental criteria

- The FTT is more energy efficient, entailing lower pressure on woody resources owing to its lower fuelwood consumption, i.e. less than 0.8 kg of fuelwood per kilogram of fish as against 3–5 kg with a traditional drum, thus emitting lower amounts of greenhouse gases (GHGs) into the atmosphere, or less pollution.
- It also strengthens fisheries communities' adaptation and resilience to climate change, especially by optimizing alternative fuels such as local biomass and agricultural residues and waste.
- In contrast, traditional kilns emit, for example, levels of carbon monoxide (CO) significantly higher than the maximum limits allowed by the European Union (Member Organization).

Social and public health criteria

- The FTT represents a useful tool to mainstream gender concerns for women, who constitute the majority of fish processors in all post-harvest activities.

- Unlike traditional systems, the FTT offers decent working conditions, reduced occupational safety and health risks, and other social assets for value-chain actors: processors using the FTT are less exposed to direct heat, burns, smoke and toxic gases, and, hence, are less prone to occupational diseases compared with their traditional counterparts, among whom the prevalence of eye, lung and skin diseases is relatively high.

Financial and economic criteria

In comparison with the traditional fish processing systems, the FTT:

- necessitates a higher upfront investment (USD 381–1 668 depending on the prototype, as against USD 25 for a traditional drum oven);
- has a longer lifespan of 3–20 years depending on the component and the type of material used (a vibrated kiln can last more than 25 years), while a traditional drum normally lasts 2 years depending also on the type of material used (kneaded clay, clay bricks, or mud);
- enhances the holding capacity of the kilns by 15 times (0.5–3 tonnes/day as against 150–200 kg with a traditional 3 cut-up drum kiln and 3 times less with a drum);
- reduces post-harvest losses (PHL);
- yields larger volumes (thanks to its higher holding capacity) of safer and higher-quality products;
- offers processors the possibility to carry out other income-generating activities (IGAs) such as adding value to fish and fishery products, sale of inputs (especially on the facilities) besides fish processing, thereby leading to higher incomes for processors;
- creates job opportunities for local artisans to craft FTT components.

Table 4 compares the FTT and traditional fish smoking systems based on the criteria outlined above. It should be noted that these criteria are inextricably linked. For example, the quantity of fuelwood and alternative fuels can be considered both financial and economic criteria (because of their costs) and environmental criteria (because of their environmental impacts).

COMPARATIVE SWOT OF THE FTT AND TRADITIONAL SYSTEMS

Table 5 compares the respective SWOT of the FTT and traditional fish smoking systems. It is based on field surveys conducted among women fish smokers and traders as well as institutional partners in Angola (Mindjimba, 2017b), Côte d'Ivoire (Anoh *et al.*, 2018; Diomandé, undated; Mindjimba, 2017a; Ziehi, 2016), Ghana (Bomfeh, 2016) and the United Republic of Tanzania (Kissai and Mgawe, 2017). It also includes findings from field investigations elsewhere (Ndiaye, Komivi and Diei-Ouadi, 2015). The related analysis focuses on internal factors (strengths and weaknesses) on the one hand and external factors (opportunities and threats) on the other hand that have an impact (either positive or negative) on any of the systems. The external factors do not vary much from one system to another as the systems are practised in the same environment and under the same conditions.

It should be recalled that assets, success factors, available resources and comparative advantages represent strengths, while pitfalls, problems to avoid or areas to improve represent weaknesses. Moreover, technological innovations, sector policies, food consumption habits and preferences are examples of opportunities, whereas obstacles and non-compliance with food quality standards are threats. Most criteria included in the table are grouped under more or less the same headings of Table 4, i.e. technical, social and health, economic, safety and environmental criteria.

TABLE 4
Comparison of the FTT with other fish smoking systems

Criteria	Smoking kilns		
	FTT	Chorkor	Traditional (3 cut-up drums)
Technical			
Design	Built on existing improved kilns (Banda, Chorkor, Altona) while correcting their deficiencies	Improved	Rudimentary
Processing time	Short (3–5 hours depending on fish species)	Medium (0.5 day–1 day)	Long (0.5 day–3 days)
Flames & smoke control	Very high	Limited	Very limited
Risk of fire	Very low ¹	Low	High ²
Smoking technique	Separate cooking (smoking) & drying	Separate cooking (smoking) & drying	Simultaneous cooking (smoking) & drying
Smoking process	Indirect	Direct	Direct
Fish protection mechanism against contamination	Present	Absent	Absent
Components	Present	Absent	Absent
Usage relative to weather conditions	Can be used in all seasons regardless of weather	Cannot be used during rainy season or humid weather	Cannot be used during rainy season or humid weather
Safety & quality of end products			
Safety & quality of smoked fish	Safer and higher-quality fish	Lower-quality fish	Lower-quality fish
PAH & MTE levels ³	Low (0.9 µg of PAH/kg of fish)	High (69 µg of PAH/kg of fish)	High (61 µg of PAH/kg of fish)
Colour & appearance	Golden colour, nice, shiny & uniform appearance	Dark brown colour, loosely adherent skin	Blackish, loosely adherent skin, inconsistent appearance
Texture	Firm	Hard	Hard
Taste	Pleasant	Bitter (presence of tar particles & PAHs)	Bitter (presence of tar particles & PAHs)
Smell	Characteristically good	–	–
Shelf-life	Prolonged (5–6 months)	Short	Short
Environmental criteria			
Fuelwood consumption	Low (0.8 kg fuelwood/kg fish)	Medium (>0.8 kg fuelwood/kg fish)	High (3–5 kg fuelwood/kg fish)
Environmental impact	Limited (low GHG emissions into the atmosphere, low fuelwood consumption ...)	Negative (GHG emissions into the atmosphere, deforestation, degradation of mangroves ...)	Negative (GHG emissions into the atmosphere, deforestation, degradation of mangroves ...)
Climate change	Resilient to climate change	Non resilient	Non resilient
Social & public health criteria			
Exposure to heat, burns, smoke & toxic gases	Very low	Frequent	Frequent
Sanitary & security impacts	Limited risks of occupational diseases	Prevalence of eye, lung & skin diseases that can cause death	Prevalence of eye, lung & skin diseases that can cause death
Financial & economic criteria			
Upfront investment	High (USD 381 –1 668)	Medium (USD 331)	Low (USD 25)
Lifespan of kiln	Long (3–12 years & 15–20 years)	Medium (3–15 years)	Short (2 years)
Holding capacity	High (0.5–3 tonnes/day)	Medium (200–300 kg/day)	Low (150–200 kg/day)
Post-harvest losses	Reduced	Limited	High
Processors' income	High	Medium	Medium
Possibility of carrying out income-generating activities & creating ancillary jobs	Very high	Medium	Limited

¹Based on the “zero flame and zero smoke” concept, produced during smoking.

²Oil applied onto metal-drum kilns (as is the custom in artisanal fisheries communities in Côte d'Ivoire) can catch fire.

³PAH = polycyclic aromatic hydrocarbons; MTE = metallic trace elements (tends to substitute for the term “heavy metals” such as mercury, lead, cadmium and arsenic).

Sources: Anoh *et al.* (2018); Bomfeh (2016); Bomfeh *et al.* (2016); Bomfeh *et al.* (2018); Mindjimba (2017a); Ndiaye, Komivi and Diei-Ouadi (2015); Traoré (undated); World Bank Group, FAO and IFAD (2015); Ziehi (2016); Zinsou and Wentholt (1989).

TABLE 5
SWOT analysis of the FTT and traditional fish smoking systems

Factors	Fish smoking systems	
	FTT	Traditional systems
Strengths	<ul style="list-style-type: none"> • Components easy to assemble¹ • Protects fish from risk of contamination (trays are covered) • Can be used in all seasons (regardless of weather) • Shortens smoking time (about 3–5 h depending on fish species, lean or fatty)² • Increases holding capacity (0.5–3 tonnes/day) • Polyvalent (smoking, drying and storage) • Long lifespan (3–12 years & 15–20 years) (Table 4) • Yields safer, superior and more uniform quality products, more competitive and highly appreciated³ • Reduces post-harvest fish losses (PHFL) • Increases the range of products and species that can be processed (e.g. fish, shellfish, crustaceans ...) • Prolongs shelf-life of processed (smoked, dried) fish (5–6 months) • Diversifies and adds value to fishery products (e.g. sausages, croquettes, stuffed fillets, fish fat)⁴ • Optimizes use of local biomass/agricultural wastes⁵ • Increases incomes & generates additional incomes⁶ • Financially and economically profitable (see Chapter 6) • Facilitates structuring and organization of fish processors into cooperative societies⁷ • Protects processors' health, improves their working conditions and reduces drudgery⁸ • Reduces environmental impact⁹ • Improves energy efficiency (less fuelwood consumption) • Strengthens fisheries communities' adaptation and resilience to climate change¹⁰ 	<ul style="list-style-type: none"> • Easily constructed, with cheap local materials¹ • Uses family labour • Transportable (case of metal-drum kilns) • Uses indigenous knowledge and know-how regarding fish smoking and use of kilns
Weaknesses	<ul style="list-style-type: none"> • Lengthy wait to use the infrastructure in place because of collective use¹¹ • Relatively high upfront investment (US 381–1668 depending on the prototype)¹² • Limited mastery of FTT kilns operation and maintenance by some fish processors • Family labour cannot be easily used on a community infrastructure 	<ul style="list-style-type: none"> • Long process (0.5 days–3 days depending on fish species and need to re-smoke unsold products), laborious and time-consuming • Need to remove and interchange trays to allow them to cool down (tedious work) • Need to re-turn the fish one by one regularly to make the smoking uniform • Installed in open air or rudimentary smokehouses • Exposes fish to bad weather and risks of contamination (uncovered trays)¹³ • Short lifespan of kilns (2 years) • Exacerbates PHFL¹⁴ • Fish usually burnt (intense fire), hence can crumble easily • Deficient in food safety, with high PAH levels (61–69 µg/kg of fish) • Prevalence of eye and lung diseases¹⁵ • Risks of skin diseases and typhoid¹⁶ • Poor working conditions and strain¹⁷ • Burns large amounts of fuelwood • Increases GHG emissions¹⁸
Opportunities	<ul style="list-style-type: none"> • High demand for smoked and dried fish¹⁹ • Existing markets for safe and quality processed products • Affordable price of fish (compared with other animal protein sources such as meat) • Conducive sector policy, legal and regulatory frameworks²³ • Effective stakeholder and community participation and engagement²⁴ • Support by development agencies, including FAO • Willingness and commitment of other donors (e.g. African Development Bank) to support this innovation 	<ul style="list-style-type: none"> • High demand for smoked and dried fish²⁰ • Establishment of the FTT²¹ • Existing national regulations on GHG emissions into the atmosphere²² • Existing national regulations regarding PHL reduction²¹
Threats	<ul style="list-style-type: none"> • Malfunction resulting from users' inadequate expertise that can lead to technical malfunctions • Long distance²⁵ • Non-compliance with good hygienic practices (GHPs)²⁶ • Low consumer purchasing power, education and awareness of potential benefits of the FTT • Risk of theft of stored products and components 	<ul style="list-style-type: none"> • Establishment of the FTT²⁰ • Non-compliance with GHPs²⁶ • Deforestation and mangrove degradation²⁷ • Existing regulation on environment protection

- ¹ FTT components can be crafted by local artisans using locally available materials (firebricks and waste materials), whereas traditional kilns are made up of readily available cut-up barrels, metal drums, clay, mud.
- ² As such, processors can engage on other pursuits, including household chores, caring for children as well as income-generating activities (IGAs) on the FTT platform (e.g. sale of food packaging items, washbasins, internal savings and loan system).
- ³ Owing to lower PAH levels, firm texture and attractive appearance.
- ⁴ Fat gathered from fat-collection tray can be used to make soap.
- ⁵ Examples are coconut husks and shells, corn cobs and straws, peanut shells, millet and rice stalks, sugar-cane bagasse, dried baobab fruits (as is the case in Cuanza Norte Province in Angola) and butane gas.
- ⁶ Resulting from sale of by-products and IGAs (see Note 2 above) as well as ancillary jobs for local artisans (e.g. carpenters, blacksmiths, welders, trimmers, cutters) for crafting FTT components.
- ⁷ The running of FTT pilot platforms in Côte d'Ivoire is a good example.
- ⁸ Resulting from their less exposure to heat, burns, smoke and toxic gases.
- ⁹ Resulting from less fuelwood consumption, and hence less deforestation and degradation of mangroves, less GHG emissions as well as use biomass and agricultural wastes and residues (see Note 5 above).
- ¹⁰ Thanks to an increased range of products and species that can be processed.
- ¹¹ Resulting from the collective use of the community-based FTT (as is the case of the FTT platforms in Côte d'Ivoire) in relation to the number of potential users.
- ¹² Out of reach for most smallholders.
- ¹³ Risks of contamination by insects, rodents, bird droppings, airborne particles, wood dust, etc.
- ¹⁴ Can exceed 50 percent of the catch throughout the value chain – about 23 317 tonnes worth almost USD 11.6 million each year in Côte d'Ivoire, according to available estimates (Diomandé, undated; FAO, 2016d), especially during the rainy season and humid weather, thus requiring re-smoking and re-drying (or additional fuelwood) to minimize rancidity; note that re-smoking and re-drying lead to smaller and lighter products, which are sold at lower prices.
- ¹⁵ Resulting from smoke and toxic gases (mainly CO and CO₂) inhalation that can cause death.
- ¹⁶ Resulting from poor personal care and insalubrity of the working environment. This could lead to conflicts with spouses because of persistent smoked fish smell – a study undertaken among fisheries communities in Yopougon-Abobo-Doumé, Côte d'Ivoire (Mambo-Gnakalé, 2015) revealed that 55.3 percent of women fish smokers interviewed had conflicting relationships with their husbands.
- ¹⁷ Unlike Note 8 above, resulting from frequent exposure to heat, burns, smoke and toxic gases.
- ¹⁸ A recent study (Anoh *et al.*, 2018) within fisheries communities in Côte d'Ivoire showed that the larger the number of fish smokers on a location (case in Grand-Lahou), the higher the likelihood that they would suffer from lung diseases (mainly bronchitis) resulting from fish smoking (60 percent of them) as compared with locations with a lower concentration of smokers (case in Braffedon, where only 35 percent of them suffered from such pathologies). Fish smokers' health status is also correlated with the length of their involvement in fish smoking: the longer their involvement in the activity, the higher their tendency to suffer from diseases associated with fish smoking and vice versa (the shorter the involvement, the lower the risk of occupational diseases).
- ¹⁹ It is estimated that 20–30 percent of fish caught in Côte d'Ivoire are smoked and consumed in this form (WAEMU, 2012–14); the proportion is higher in Ghana, being 70–80 percent of domestic fish catch (Bomfeh, 2016).
- ²⁰ The establishment of the FTT represents both an opportunity (in terms of improvement) and a threat (in terms of obsolescence) to the traditional systems – the threat here is viewed from the traditional-system perspective, not from their improvement objective.
- ²¹ Likewise the establishment of the FTT, such a regulation – an example is Order No. 01164/MINEEF/CIAPOL/SIIC of 4 November 2008 regulating greenhouse releases and emissions from classified installations for environmental protection in Côte d'Ivoire – represents both an opportunity (in terms of improvement) and a threat (in terms of obsolescence) to the traditional fish smoking systems.
- ²² The programme for the widespread dissemination of the FTT in Côte d'Ivoire is a good example.
- ²³ As provided for, for example, under the National Livestock, Fisheries and Aquaculture Strategic Development Plan (PSDEPA) 2014–2020 in Côte d'Ivoire.
- ²⁴ Financing the FTT warehouses in Côte d'Ivoire by the local community and the regional councils are good examples.
- ²⁵ The distance from the intended users' home to the nearest FTT platform in place is a determining factor in adoption of this new technique.
- ²⁶ For example, the use of untreated rainwater and water from the wells to wash raw fish and utensils prior to smoking.
- ²⁷ It is estimated (Diomandé, undated) that about 112 000 tonnes of fuelwood (worth about USD 3.6 million) are lost each year in Côte d'Ivoire as a result of fish smoking. Sources: Anoh *et al.* (2018); Bomfeh (2016); Diomandé (undated); Kissai and Mgawe (2017); Mindjimba (2017a, 2017b); WAEMU (2012–14); Ziehi (2016).

CONCLUSION

The FTT inherently offers more strengths (and conversely less weaknesses) than do traditional fish smoking systems. The few weaknesses of this new technique include: the relatively high upfront investment (USD 381–1 668 depending on the prototype); the fact that, because of the limited number of FTT kilns presently put in place, several fish processors continue to use their traditional kilns; the prevailing non-price differentiation on domestic markets (Africa and Asia) in particular; and consumer behaviour regarding FTT end products and those resulting from traditional methods on the local and domestic markets. However, the changing business environment towards increasing demand for safety and quality standards should soon compel wider adoption of the FTT technology.

Chapter 6

Benefits of the FTT

INTRODUCTION

Since its introduction, the FTT has shown that it can bring about significant improvements to almost every aspect of hot-fish smoking, be it in terms of compliance to food safety aspects guaranteeing consumer protection or processors' working conditions, livelihoods, health, social capital and well-being, environmental protection or economic returns, partially thanks to the reduction of PHFL. These benefits have been well documented in the literature (Anoh *et al.*, 2018; Bomfeh *et al.*, 2016; Bomfeh *et al.*, 2018; Kissai and Mgawe, 2017; Diei-Ouadi, Randrianantoandro and Ndiaye, 2017; Mindjimba, 2017a; Ndiaye, Komivi and Diei-Ouadi, 2015; Randrianantoandro, 2015; Randrianantoandro and Diei-Ouadi, 2015; Rotawewa and Wickramasinghe, 2018; World Bank Group, FAO and IFAD, 2015), in news articles and in reports from projects in which the FTT technique was implemented. This chapter highlights some of the FTT's most significant benefits and underlines the importance of embedding social and capacity-strengthening dimensions in any dissemination endeavour to ensure, as much as possible, its proper and complete adoption by the intended users.

SAFETY OF FTT PRODUCTS, CONSUMER PROTECTION

The main and original reason for the design of the FTT was to respond to the overall safety problem of high PAHs in smoked fish (Ndiaye, Komivi and Diei-Ouadi, 2015). Compared with Asia, smoked fish producers in more African countries are targeting the market of the European Union, the first market to have set standards for PAHs and tightly regulated them. This was the reason for Africa's active request to FAO in early 2005 for assistance in addressing the compliance challenge, for better market connectivity. Indeed, barring the effect of raw-material quality, PAHs could be considered the most important chemical contaminants associated with traditionally hot-smoked fish in Africa. This is particularly so in terms of their degree of occurrence relative to other food safety hazards and their impact on health. For example, whereas microbiological hazards such as *Salmonella* sp. were not detected in smoked fish sampled immediately after processing nor in those sampled from informal markets in Ghana, PAHs were detected in the same products at levels exceeding 400 µg/kg (Bomfeh *et al.*, 2016; Bomfeh *et al.*, 2018). In another study in the same country, whereas *Listeria monocytogenes*, *Vibrio* sp. and *Salmonella* sp. were not detected in smoked fish on informal markets, PAH levels in the same products exceeded 200 µg/kg (Antwi and Beran, 2018).⁵ It is noteworthy that the smoked fish in both studies were processed with traditional kilns.

While cooking may eliminate some microbiological hazards in smoked fish (depending on the time–temperature regime), it will not eliminate PAHs once contamination of the product with the latter hazard has occurred. Moreover, whereas microbiological contaminants, should they survive cooking, may generally cause acute gastroenteritis that may be treated at a relatively low cost, the main potential adverse

⁵ In both studies cited, PAH refers to the sum of benzo(a)pyrene, benzo(b)fluoranthene, benzo(a)anthracene and chrysene.

health effect of PAHs is cancer, whose treatment is much more resource-demanding.⁶ Thus, the impact of PAHs on both public health and the public purse cannot be overemphasized. In light of the high FSN significance of smoked fish in Africa and Asia, the health and economic implications of the PAH challenge in those settings are immediately noticeable.

The occurrence of PAHs in smoked fish is critically dependent on kiln design and the type of fuel used for processing. In view of this, the Codex Alimentarius Commission has provided various instruments aimed at reducing PAH levels in this commodity. These instruments recognize the use of fuelwood, distance between food being smoked and heat source, fat content of food, smoking time, smoking temperature, and kiln cleanliness and maintenance as the main parameters affecting PAH levels in smoked products (CAC/RCP 52-2003; CAC/RCP 68-2009; CODEX STAN 311-2013 [CAC, 2003, 2009, 2013]). As explained in Chapter 3, unlike traditional kilns, the FTT was designed to leverage on knowledge and guidance from these documents to protect public health *vis-à-vis* PAHs. The degree to which that is the case has been evaluated in studies in Côte d'Ivoire, Ghana and Senegal. In the specific case of Ghana, comparative smoking experiments were conducted with the FTT and two traditional kilns (Chorkor smoker and metal-drum kiln).

First, the impacts of fuel type and product type on PAH levels – specifically B(a)P and PAH4 levels – were determined for each kiln, and comparisons made. Second, the impacts of the various design features of the FTT on PAH levels were determined. Finally, a risk assessment was conducted to determine the public health implications of using each kiln to smoke fish. All smoking experiments were conducted on actual kilns (not laboratory-scale equipment) by women fish processors who had more than three decades of experience in these activities. The highlights of findings from those studies are presented in the following sections.

Comparison of FTT with traditional kilns: PAHs in smoked fish

The findings in Ghana corroborate results from Côte d'Ivoire and Senegal in demonstrating that the FTT yields smoked products with PAH levels that are far lower than those in products from the traditional kilns (Bomfeh *et al.*, 2016; Bomfeh *et al.*, 2018; Ndiaye and Diei-Ouadi, 2012; Traoré, undated). In Ghana, whereas levels of the hazard in FTT products were lower than current maximum limits allowed in the European Union (Member Organization), products from traditional kilns exceeded the limits by up to 33 times (Table 6 and Figure 23). In Côte d'Ivoire, PAH4 levels in FTT products were found to be 6–40 times lower than the levels in the same fish (tuna-like species or catfish) using a traditional clay kiln (Traoré, undated). In Senegal, whereas B(a)P in FTT products ranged from 0.15 µg/kg to 1.50 µg/kg, levels of the same hazard in other kilns were above 5 µg/kg (Ndiaye and Diei-Ouadi, 2012).

⁶ This information by no means downplays the food-borne illness significance of microbiological hazards. In the context under discussion, cooking generally requires high temperatures and longer times that would be lethal to most vegetative pathogenic microorganisms but have no mitigating impact on PAH levels. Should such foods be re-contaminated with pathogens post-cooking, illness may follow consumption. The information therefore highlights the importance of PAHs in smoked fish without minimizing the importance of microbiological hazards.

TABLE 6
PAH4 levels in smoked-dry *Sardinella* sp. (FTT vs traditional kilns)

Fuel	Kiln	Mean PAH4 ($\mu\text{g}/\text{kg}$) (n=5)
<i>Pterocarpus erinaceus</i> (Esa)	FTT	37.70 \pm 2.48
	Chorkor smoker	394.48 \pm 16.48
	Metal-drum kiln	135.70 \pm 11.32
<i>Azadirachta indica</i> (Neem)	FTT	28.86 \pm 1.98
	Chorkor smoker	206.98 \pm 10.14
	Metal-drum kiln	174.30 \pm 22.82
Charcoal (for cooking step) and sugar-cane bagasse (for smoke flavouring step)	FTT	1.50 \pm 0.11
	Chorkor smoker	39.38 \pm 1.94

Note: *Pterocarpus erinaceus* and *Azadirachta indica* were cited by the processors in the study to be among the most common fuelwoods used for fish smoking in Ghana.

Sources: Bomfeh et al. (2016); Bomfeh et al. (2018).

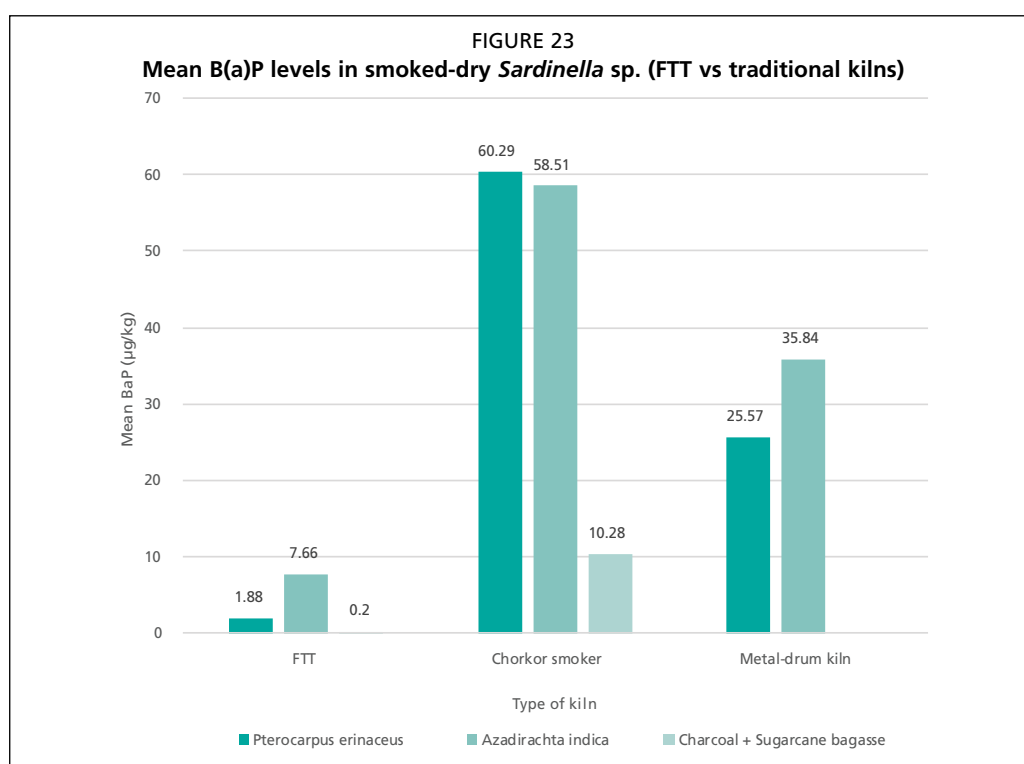

Sources: Bomfeh et al. (2016); Bomfeh et al. (2018).

Overall, the findings demonstrate the superiority of the FTT in respect of low PAH levels as follows:

- When operated as their design requires (i.e. FTT fuelled with fully lit charcoal and heat-retention stones followed by flavouring with filtered smoke, while traditional kilns are fuelled by fuelwood), FTT yields products with lower PAHs than do traditional kilns.
- When both the FTT and traditional kilns are fuelled with the same fuelwood, FTT products record lower PAH values than do traditional kiln products.
- When the Chorkor smoker is fuelled with fully lit charcoal and heat-retention stones, followed by flavouring with smoke from sugar-cane bagasse (to mimic the FTT in terms of fuel choice), its products record higher PAH levels than do FTT products.

These findings show that irrespective of the fuel type used, FTT products have lower PAH levels than do traditional kiln products. However, using fuelwood as cooking fuel in the FTT resulted in violation of the maximum limits set by the European Union (Member Organization) for the hazard. This highlights the importance of both kiln design and fuel choice on PAH levels of smoked fish. Moreover, it highlights the importance of following the recommended protocols for the operations of the FTT (Ndiaye, Komivi and Diei-Ouadi, 2015).

Impact of FTT components on PAH levels

Having established the efficacy of the FTT, the individual impacts of the features of the innovation on PAH levels were tested. The components of interest were: the type of cooking fuel; the fat-collection tray; the type of material for smoke flavouring; and the filter. The components had varying degrees of impact on product PAH levels, as explained below.

Impact of fully lit charcoal and heat-retention stones as heat source

The contribution of the combination of fully lit charcoal and heat-retention stones to PAH levels appeared minimal. At the end of the cooking step, levels of both B(a)P and PAH4 in the products were less than the analytical level of quantification (0.02 µg/kg) (Bomfeh *et al.*, 2016; Bomfeh *et al.*, 2018). This rose to 0.35 µg/kg for B(a)P and 1.46 µg/kg for PAH4 after the products were smoke-flavoured. However, as observed in Table 6 and Figure 23, the use of fuelwood in lieu of charcoal resulted in violating the maximum limits set by the European Union (Member Organization) for the hazard. The data corroborate findings by Ndiaye, Komivi and Diei-Ouadi (2015) on the significant impact of cooking fuel type on PAH levels in FTT products. In addition, the data provide a reason for the observed high PAH levels in traditional kiln products.

Impact of the fat-collection tray

The maximum limits set by the European Union (Member Organization) were violated when the fat-collection tray was not used during the smoking of fatty fish (Bomfeh *et al.*, 2016; Bomfeh *et al.*, 2018). With the fat-collection tray in place, B(a)P and PAH4 levels were 0.5 µg/kg and 4.5 µg/kg, respectively, whereas values when the tray was not used were 2.9 µg/kg and 38.4 µg/kg, respectively. The pyrolysis of fish-fat drippings in direct contact with the heat source could explain the higher PAH levels when the fat-collection tray was not used. This also provides an additional reason for the high PAH levels in traditional kiln products, given that such kilns have no component to prevent fat drippings from falling onto the heat source.

Impact of material for generating smoke

Sugar-cane bagasse and coconut husk are among the recommended materials for generating smoke to flavour fish on the FTT (Ndiaye, Komivi and Diei-Ouadi, 2015). Tests showed that neither material caused violation of the maximum limits set by the European Union (Member Organization). However, of the two materials, coconut-husk smoke contained more PAHs (0.28 µg/kg vs 0.20 µg/kg B(a)P; 1.70 µg/kg vs 1.50 µg/kg PAH4). The practical relevance of this difference could be considered minimal, as levels of the hazard associated with each material were within acceptable limits.

Impact of the smoke filter

When the smoke filter was not used, PAH levels were higher in products (0.36 µg/kg vs 0.88 µg/kg B(a)P; 1.5 µg/kg vs 7.9 µg/kg PAH4). Therefore, the filter could be considered effective in trapping tar particles to reduce the extent of their

deposition on products. The absence of this mechanism in traditional kilns further contributes to high PAH levels in their products.

From the foregoing, it is seen that, ranked from highest to lowest, the impact of FTT components on PAH levels would be: the type of cooking fuel; the use or non-use of the fat-collection tray; the use or non-use of smoke filter; and the type of material used for generating smoke.

Recommendations

- Given the high PAH levels associated with traditionally smoked fish and their attendant risks for processors and consumers, governments should make policy commitments to phase out traditional kilns.
- Governments should make policy commitments to adopt the FTT (and adapt same to their context) to protect public health.
- The operation of the FTT should be in strict compliance with the recommended mode of use.
- Use of wood as fuel with the FTT should be discouraged, and ideally, greening the value chain by integrating solar or biogas energy in the cooking phase within the smoking process should be explored and fostered.

Risk assessment for PAH levels in smoked fishery products (FTT vs traditional kilns)

As stated above, the main public health concern linked to PAHs lies in their potential to cause cancer. The risk of cancer associated with fish smoked with the kilns under study was estimated using the “margin of exposure” (MOE) approach. The MOE is a dimensionless number offering a barometer for the degree of concern that risk managers must give food safety hazards. It is computed as a ratio between the lower limit of the dose of a hazard that is able to produce a low but measurable deleterious effect (benchmark dose level, BMDL₁₀), and the actual exposure of a population to the same hazard (EFSA, 2008). The Joint FAO/WHO Expert Committee on Food Additives (JECFA, 2006) and the European Food Safety Authority (EFSA, 2008) have provided BMDL₁₀ values for B(a)P and PAH4 (100 µg/kg bw/day and 340 µg/kg bw/day, respectively). An MOE of less than 10 000 indicates a public health threat that requires risk management action, and vice versa.

The exposure of consumers in Ghana to B(a)P in fish smoked either using the FTT or traditional kilns was determined, based on the concentrations of the hazards in the products and data on the smoked fish consumption habits in the country. The MOE values (Table 7) suggest that, whereas consumption of traditional kiln products raises public health concerns, consumption of FTT products will not. Given the widespread use of traditional kilns across Africa and Asia, the important role of smoked fish as protein source in such settings, and the high levels of PAHs in traditionally smoked fish, similar findings are expected in such contexts. A study (Tongo, Ogbeide and Ezemonye, 2017) conducted in Nigeria, for example, found PAH4 levels ranging from 160 µg/kg to 470 µg/kg in traditionally smoked fish on informal markets and found risks for cancer higher than allowed by the United States Environmental Protection Agency. The study linked this observation to the use of traditional kilns and recommended the use of safer alternatives for smoking fish.

The implications from these PAH risk assessments are two-fold: (i) risk management action is required on PAHs in fish smoked on traditional kilns; and (ii) the FTT is demonstrably an efficacious kiln that could help mitigate the risk.

TABLE 7
Margin of exposure for B(a)P in *Sardinella* sp. and *Sphyraena* sp. smoked using the FTT and traditional kilns in Ghana

Kiln	Population	Margin of exposure		
		Mean	Median	95th percentile
Chorkor smoker	Adults	1 857	2 447	706
	Children	572	7 342	2 119
Metal-drum	Adults	2 556	3 368	972
	Children	7 668	10 104	2 916
FTT	Adults	129 099	170 122	49 102
	Children	387 298	510 367	147 307

Sources: Bomfeh *et al.* (2016); Bomfeh *et al.* (2018).

It must be emphasized that the foregoing risk assessment considers exposure to the hazard only through smoked fish. It is estimated that in non-occupational settings, up to 70 percent of PAH exposure occurs through food (Rengarajan *et al.*, 2015). Should other smoked food products (such as game) be considered, the concern would be higher.

In addition, other routes of exposure to PAHs, namely skin contact and inhalation, are also important in the impacts they have on health. For example, acute effects such as eye irritation, skin irritation, nausea, vomiting and confusion could result from such exposures (Bølling *et al.*, 2009; Kim *et al.*, 2013), without precluding the possibility for chronic effects (such as leukaemia and cancer) to follow in the future.

As a result of the nature of their work and being consumers of smoked fish, processors who use traditional kilns, most of whom are women, are exposed to all three routes of exposure. In fact, they suffer from high exposure for practically all of their working lives. The deleterious health impacts of PAHs on these women are therefore seriously compounded, thus compromising their access to, and experience of, good health and well-being (SDG 3), gender equality and empowerment (SDG 5), and decent work (SDG 8).

In view of this, serious commitment is needed at the policy level to phase out traditional kilns and promote the use of improved kilns proven to be efficacious through sound science, such as the FTT. Standards and regulations that reflect the specific challenges of the fisheries sector in Africa and Asia should also be developed based on scientific risk assessments, which have been found to be lacking in those regions in terms of providing a context-relevant basis for standards (Djessouho, 2018).

Recommendation

- Governments should commit to conducting risk assessments for processing-related food safety hazards in the smoked-fish value chain in order to provide an evidential basis for policy.

REDUCTION OF POST-HARVEST LOSSES

Post-harvest losses (PHL) are a major challenge to FSN globally. They diminish or, in some cases, completely eliminate, both the nutritional and economic benefits that could be derived from agricultural and fisheries resources after primary production. It is estimated that about 1.3 billion tonnes of food are lost each year, with losses in fishery products alone estimated to be as high as 35 percent (FAO, 2018b). Therefore, in the face of the increasing global population, climate change, increasing urbanization and rising food prices, global efforts are being canvassed to reduce such losses to ensure availability of food for all people at all times. This would also increase the real income of both consumers and food processors and producers (World Bank, 2011). In pursuance of this, SDG 12.3 demands a commitment to support such efforts at

reducing food losses globally. FAO is also championing the Global Initiative on Food Loss and Waste Reduction (Save Food Initiative).

Following the 2007–08 food crises, food security became a permanent and high policy priority for the Association of Southeast Asian Nations (ASEAN). This led to the adoption of the Integrated Food Security Framework and the Strategic Plan of Action on Food Security in the ASEAN Region (SPA-FS 2009–2013 and SPA-FS 2015–2025 [ASEAN, undated]). Among the objectives of SPA-FS 2015–2025 is a commitment to reducing PHL.

In Africa, in light of the fact that in SSA alone PHL occurs at levels of up to 50 percent of food production (Deloitte and Touche, 2015), the heads of state at the 2014 African Union Summit in Malabo, Equatorial Guinea made a specific commitment to halve PHL on the continent by 2025 in what is called the Malabo Declaration. This enjoins leaders on the continent to design and implement policies that demonstrate overt fidelity to the Malabo Declaration. In that regard, it is important to keep in view that along the Volta Basin riparian countries alone, PHL in fisheries was estimated at 27 percent on average and could be as high as 46 percent (Diei-Ouadi *et al.*, 2015). The loss elements mapped out along with identified priority areas for interventions partially informed the Policy Framework and Reform Strategy of Fisheries and Aquaculture in Africa (PFRS) adopted by African heads of state and government in 2014. The subsequent Volta Basin Strategy developed in 2016 marked the efforts of the riparian countries of the Volta Basin to implement the reforms endorsed by the instruments of the African Union Summit (FAO, 2016c).

Methods of food processing have been cited as contributing to the high levels of PHL in developing countries (FAO, 2011). In Africa and Asia, hot-smoking is an important processing method for reducing PHL in fish (Peñarubia, Randrianantoandro and Diei-Ouadi, 2018). The FSN and economic benefits of the practice cannot be overemphasized. This suggests that interventions in methods of fish smoking will make significant contributions to the efforts of these regions to achieve the goals of reducing PHL in fishery products.

The Code of Conduct for Responsible Fisheries (the Code [FAO, 1995]) highlights the development and use of appropriate technologies as key to reducing PHL in fishery products. It is complemented by the FAO 2015 Voluntary Guidelines for Securing Sustainable Small-Scale Fisheries in the Context of Food Security and Poverty Eradication (SSF Guidelines) and more specifically by Chapter 7 thereof, which provides guidance on post-harvest issues (FAO, 2015a). Both of these instruments should therefore guide policymaking and implementation, with the FTT being a proven viable option.

As explained in Chapters 2 and 3, the aim of reducing PHL featured prominently in considerations that led to the development of the FTT. With its polyvalent character, it can be used for smoking, drying and storage of (processed) fish (Ndiaye, Komivi and Diei-Ouadi, 2015). These diverse applications could reduce PHL with less charring of products (more consistent outputs) and, during bumper seasons, processors could transform several types of fish into varied products. In addition, the reduced processing time coupled with its higher holding capacity (i.e. quantity of fish that can be smoked at a time) translates into larger throughput, which invariably contributes to reducing PHL.

As explained above, FTT yields smoked products with low PAH levels that pass regulatory limits in the European Union (Member Organization). This quality improvement offers great gains in PHL reduction, because a loss in fish quality is considered a PHL (Diei-Ouadi and Mgawe, 2011). For example, rejections of smoked fish from Africa at European borders on grounds of unacceptable safety quality constitute a major source of PHL of the commodity (Peñarubia, Randrianantoandro and Diei-Ouadi, 2018). In 2003, it was estimated that one out of every four

consignments of smoked fish entering the United Kingdom of Great Britain and Northern Ireland from Africa was detained, from which quantities with a retail value of up to USD 640 000 were destroyed per detained unit (Ward, 2003).

Border rejections of the commodity by the European Union (Member Organization) are often due to high levels of PAHs and are publicized on the Rapid Alert System for Food and Feed (RASFF) (Table 8). The number of RASFF alerts does not necessarily show the extent of the PAH problem in exporting countries, given that it captures only the fraction associated with products arriving at borders of the European Union.

TABLE 8
RASFF notifications on unacceptable PAH levels in smoked fish exports from selected African countries and one Asian country to the European Union (Member Organization), 2006–2018

Country	Number of notifications resulting from unacceptable PAH levels in smoked fish ¹												
	2006	2007	2008	2009	2010	2011	2012	2013	2014	2015	2016	2017	May 2018
Côte d'Ivoire	1	6	–	–	–	–	–	1	–	–	–	–	–
Ghana	7	1	–	1	–	1	–	2	4	–	4	–	–
Nigeria	–	–	–	–	1	–	–	–	–	–	–	–	–
Senegal	1	1	–	–	–	–	–	–	–	–	–	–	–
Republic of Korea ²	–	–	–	–	–	–	–	–	–	–	2	–	–

¹ Compiled from data available on the RASFF portal (<https://webgate.ec.europa.eu/rasff-window/portal/?event=searchForm&cleanSearch=1>).

² The Republic of Korea was the only Asian country recording PAH alerts in the stated period. The four African countries listed were selected from the countries under study, with no particular criterion.

Linked to this is the two-pronged loss in market access and, hence, revenue. The very listing of such rejections on the RASFF dents the credibility of the exporting countries as far as the supply of safe food in general is concerned. As cited above, Côte d'Ivoire, for example, suspended its smoked fish exports to the European Union (Member Organization) for five consecutive years (2006–2011) following alerts on high PAH levels in its smoked fish. This cost the country some USD 1.6 million in lost revenue (Peñarubia, 2017). Ivorian medium-sized processing enterprises were able to resume exports to the European Union (Member Organization) with the introduction of FTT in that country.

Therefore, the ability of governments in Africa and Asia to pursue the Malabo Declaration and the SPA-FS 2015–2025, respectively, as well as SDG 12, on issues linked to the fisheries sector would be greatly enhanced through the adoption of the FTT to reduce PHL in fishery products. In fact, this innovation supports loss-reduction efforts by providing multiple fish processing options, increasing fish-smoking throughput, reducing quality losses through reduced PAH levels in products, and enhancing product marketability beyond the regional level. Thus, the FTT is a promising option for reducing quality losses and losses due to market forces (through improved product safety) as well as physical (quantity) losses.

Recommendation

- Governments should demonstrate their commitment to SDG 12 by adopting improved fish smoking systems (such as the FTT) to reduce PHFL.

DECENT WORKING CONDITIONS, REDUCED OCCUPATIONAL SAFETY AND HEALTH RISKS, AND OTHER SOCIAL ASSETS FOR VALUE-CHAIN ACTORS

Trends over a decade demonstrate the ever-increasing international attention on cases of human rights violations and labour exploitation in the whole of the fisheries and aquaculture sector. This has triggered more transparency and effective traceability of decent working conditions along the value chains. This is the result of more evidence raised by the community of social scientists and human rights advocates, fisheries

workers and consumers, and some industry stakeholders. Thus, the sector needs to find ways to embed more social accountability in fisheries supply chains in order to ensure inclusive economic development of communities and workers depending on fisheries production, processing and trade for their livelihoods and food security.

The Global Sustainable Seafood Initiative (GSSI) has included decent work and economic growth (SDG 8), and responsible consumption and production (SDG 12) in its priority targets. As stated on its website (GSSI, 2018), it has set up a Global Benchmark Tool that has the collective objective to minimize the overall environmental impact of how seafood is harvested or caught, grown and delivered to meet a growing global demand, and it is committed to exploring how social issues may be addressed in the seafood supply chain. This includes compiling information on social and labour criteria and standards for seafood commodities, as well as on interested auditing/certification schemes and other projects working on such criteria and standards for use in fisheries supply chains.

In parallel, many civil society organizations, in collaboration with seafood events, media and UN agencies are actively advocating the promotion and upholding of human and labour rights in fisheries, social protection for fisheries communities, and decent working conditions for all fish workers.

To a high degree, these advocacy instruments and actions are most likely to be effective for larger-scale / industrial fisheries, especially those that need to safeguard their brand names on international markets, as they have now to commit to corporate social responsibility. Thus, market response can reward or sanction proven malpractice, as it can be identified and assigned to specific actors. However, the predominant self-employment context that characterizes small-scale fish-processing operations makes it unique and has been the subject of much less attention. Moreover, tracing who the specific processor of the purchased smoked fish was may prove to be arduous if not impossible for consumers. This is combined with the fact that self-employed women fish processors and fishmongers may not feel that they can actually afford to work in better conditions, as the large majority of them may not have adequate knowledge and still need to take ownership of improved operations, including good handling and processing practices. Moreover, they may not have regular and/or sufficient access to an FTT infrastructure or the means to equip their own kilns with the FTT components.

Occupational health and safety risks in traditional fish smoking versus benefits of the FTT on reducing these risks

Traditional smoking

Although some research has been done on health concerns regarding fish-smoking processes, there appears to be much less on the different hazards faced by fish processors. For example, SNV Ghana's website presents the introduction of the Ahotor oven as bringing improvements to the product without clearly detailing its benefits for its direct users (SNV Netherlands Development Organisation, 2017). Moreover, the Ahotor kiln design has borrowed two of the three components of the FTT, but is yet to generate EU PAH-compliant products. Results from a study by Po, FitzGerald and Carlsten (2011) on the effects of biomass fuel use in the household confer significant risk for acute respiratory infections in children, and chronic obstructive pulmonary disease and chronic bronchitis in women.

A study was conducted by Umoh and Peters (2014) in a poor coastal fishing settlement in the Mbo local government area in Akwa Ibom State, Nigeria, where fish smoking is conducted indoors in drying huts through a week-long process and domestic cooking is done over wood-fed fires. Results showed a significant association between chronic bronchitis and impaired lung function for women exposed to high levels of fuelwood smoke, compared with the women who were not involved in

fish-smoking activities. This was corroborated by research that took place in the Oyorokoto fishing settlement in the Andoni local government area of Nigeria's Rivers State in 2016, showing an increased prevalence of respiratory symptoms and reduced lung function among the fish smokers as compared with the control group (Dienye, Akani and Okokon, 2016).

Moreover, a knowledge, attitudes and belief survey was conducted in 2018 among Nigerian commercial fishmongers. Findings showed that they had limited knowledge about the health hazards of their occupation-associated use of biomass fuels and had negative attitudes towards preventing these adverse effects despite high levels of belief that these fuels are harmful to health (Nwankwo *et al.*, 2018).

The Indian Vikaspedia portal does mention processors' health in an information bulletin on an improved fish smoking method introduced in Andhra Pradesh, which can render smoking a more comfortable activity for the processors, with fewer health hazards (King and Salagrama, undated).

Smallholder poor Sri Lankan traditional smoked-fish processors working alone seem to have a processing capacity of 10–40 kg of fresh fish per day. After cutting and cleaning, the smoking process lasts for about 10 hours on the first day. When necessary, more smoking takes place the following morning to reduce the moisture content of the previous day's batch for another 2 hours. This uses a lot of fuelwood as the cooking and smoking process happens over direct fire. This causes oil to drip onto the flames, triggering sudden fire and burning of the fish. Processors are directly exposed to the smoke and the heat, which most probably leads to pulmonary complications. In the case of rain, processing comes to a halt, and when the rain persists all the fish is lost, contributing to dire poverty because of the financial loss. To avoid sudden fire or rain damage, one person remains standing by for about 10–12 hours until the smoking process is complete, thus leaving all other household activities unattended. Poor storage was also observed, contributing to more PHL. Moreover, there are many religious festivals throughout the year, during which everyone eats a vegetarian diet and fresh-fish prices go down (Rotawewa and Wickramasinghe, 2018).

In all contexts, children playing nearby or carried on their mother's back during smoking activities are at risk of experiencing health problems.

FTT smoking

In Sri Lanka, smoking and drying times were reduced from 12 hours on two consecutive days with traditional kilns to 6–7 hours with the FTT kiln; moreover, women fish processors who shifted to this new kiln could use the freed-up time to take care of their families and carry out other household chores. An additional benefit of the FTT is an increase in the holding capacity of kilns from 16–40 kg of raw fish per day (with traditional kilns) to 100 kg of raw fish per day (with FTT kiln), i.e. 3–6 times more (Rotawewa and Wickramasinghe, 2018).

Relatively more detailed research prompted by the FTT introduction has also been conducted. Following a preliminary self-funded survey by the Université Félix Houphouët-Boigny, the Ivorian Tropical Geography Institute, FAO, and with support from the Norwegian Agency for Development Cooperation (NORAD) and the Swedish International Development Cooperation Agency (SIDA), commissioned a study in Côte d'Ivoire in 2016. The study assessed the impact of traditional fish smoking compared with fish smoking with the FTT established in 2013 within FAO regular programme funds, thereafter strengthened in 2016 through Component 2 Enable Women to Benefit More Equitably from Agro-Food Value Chains within the FMM (FMM/GLO/103/MUL) and TCP/IVC/3501. Clinical and para-clinical examinations conducted on 52 women fish smokers on artisanal processing sites in Grand-Lahou and Braffedon showed that traditional smoking results in significant production of carbon dioxide (CO₂) and other gaseous pollutants, such as PAHs. Measurements

revealed CO₂ levels (more than 150 mg/m³) above the tolerance threshold (50 mg/m³). The diseases identified in women fish smokers find their source in these particularly harmful gases coupled with the insalubrity of their work sites (Anoh, Ouattara and Ossey, 2016).

Earlier, NORAD provided support to the Ivorian Laboratoire National d'Appui au Développement Agricole through the FMM. The project was implemented as the regional project Food Loss Reduction Strategy Development in Favour of Smallholder Producers in Africa (GCP/RAF/488/NOR) by the FAO Regional Office for Africa.

From a scientific perspective, when the FTT's design complies with the prescribed technical specifications and there is adherence to its good operating practices, gaseous pollutants are kept well under the recommended maximum levels, as shown in Table 9.

TABLE 9

Gaseous-pollutant measurements at an FTT platform in Côte d'Ivoire, 2016

Guessabo FTT smoking platform	Gaseous measurement time intervals	Date	Time hh:min	CO ₂ mg/m ³	NH ₃ mg/m ³	SO ₂ mg/m ³	H ₂ S ppm	VOC1 ppm
	Measurement 1 Before lighting the fire	13/04/17	11:10	0	0	0	0	0
	Measurement 2 At the moment of lighting the fire in the kiln	13/04/17	11:20	2–4	0	0	0	0.2–0.6
	Measurement 3 At the start	13/04/17	11:30	3–10	0	0	0	0.3–0.9
	Measurement 4 After 10 minutes of fish smoking	13/04/17	11:40	8–15	0	0	0	0.3–1.3
	Measurement 5 After 20 minutes of fish smoking	13/04/17	11:50	8–18	0	0	0	0.3–0.9
	Measurement 6 After 30 minutes of fish smoking	13/04/17	12:00	9–22	0	0	0	0.5–1.5
	Measurement 7 After 6 hours of fish smoking	13/04/17	17:30	18–35	0	0	0	0.6–1.9
Concentration limit values in reference to Côte d'Ivoire's Regulation No. 01164/MINEEF/CIAPOL/SIIC of 4 November 2008.				50	–	500	–	–

¹ VOC: volatile organic compound.

Source: Anoh *et al.* (2018).

Gaseous-pollutant levels were almost acceptable at a well-ventilated open-air traditional smoking site. This most probably resulted from good air circulation. However, it does not prevent excessive heat exposure and burns for women processors, nor PAHs from depositing on the fish, given the prevailing incomplete combustion operations and ill-maintained FTT platforms. Moreover, the actual smoking time is much longer (see Chapter 4).

In fact, more than half of the 52 women examined suffered from diseases associated with their activity, with clinical examinations showing higher prevalence rates of respiratory symptoms (cough, chest pain, whistling, dyspnoea and rhinitis) and cardiovascular diseases (arterial hypertension), along with ophthalmic and ear–nose–throat spectrum infections. Cases of skin diseases and typhoid fever were also recorded, and these were even more closely linked to the lack of hygiene in the working environment.

Moreover, spirometry tests indicate that women fish smokers who employ the modern/FTT kiln are less affected by pathologies than those who continue to use the traditional ovens.⁷

While being interviewed for a survey in 2016 at the same locations, women fish processors and fishmongers listed time conflict between domestic and professional

⁷ These tests measure how much air people can move through their lungs.

work, fatigue and health risks (e.g. malaria, back pain, eye diseases and wound infections) as some of the important issues they face when smoking fish (Holvoet, 2016). Women fish processors in Burkina Faso faced the same risks (Konate, Kone and Ouedraogo, 2017). This suggests that, as in Nigeria, women in Côte d'Ivoire and Burkina Faso have limited knowledge of health issues linked to respiratory problems, as they may be less incapacitating. However, they also recognize that the FTT has greatly alleviated all of these issues (FAO, 2016d), making them less prone to health problems while feeling more energetic. Smoking and drying with the FTT can be performed regardless of weather conditions, thereby reducing PHFL – as much as 50 percent in certain operations during the rainy season or humid periods (FAO, 2016a; Ndiaye, Komivi and Diei-Ouadi, 2015; World Bank Group, FAO and IFAD, 2015).

As indicated above, the majority (as many as 90 percent in processing activities, according to FAO estimates) of fish processors in SSA in general and in the country case studies under consideration in particular are women. Therefore, women and children bear the brunt of the drudgery and health problems related to drying and smoking fish (World Bank Group, FAO and IFAD, 2015). Those using the FTT are less exposed to heat, burns, smokes and toxic gases, and hence to occupational health hazards compared with those using other processes. Consequently, their working conditions are significantly improved and their drudgery reduced in terms of comfort, hygiene and sanitation (Anoh, Ouattara and Ossey, 2016).

Whether women process the fish with traditional kilns, drying methods or the FTT, they face serious constraints related to mobility opportunities. These are further discussed below in the section on the market environment and access.

In summary, once this technology is fully recognized and properly used, it results in reduced costs related to control, analysis and seizure of products at the border inspection points upon arrival on international markets.

The FTT's social benefits

It is essential to consider the FTT's many social benefits when designing programmes, devising new infrastructure for fish processing and trade, and/or drafting policies related to fisheries or gender issues. This section looks at these in detail.

By giving processors the opportunity to pursue other IGAs or taking more care of their families, the FTT not only allows them to smoke and dry fish regardless of weather conditions, as long as the raw material – fish – is available, but it also reduces both the processing time by 2–4 times and PHFLs.

Learning how to use the FTT properly can have a ripple effect with women applying good hygienic practices (GHPs) in all areas of their lives.

Negative social aspects of traditional fish smoking identified in field studies include: husbands strongly disliking the smell of fish on their wives; fish smokers losing their fingerprints, making it difficult to obtain identification cards and official documentation; and issues of domestic violence owing to processors returning late and rising early because of women's processing activities (Anoh, Ouattara and Ossey, 2016). The use of the FTT either greatly reduces or completely resolves all of these issues.

Furthermore, with the use of this new technique, commercial activities of smallholder fish processors and fishmongers (most of whom are women) are not only potentially safeguarded but also enhanced through access to more lucrative markets (owing to the higher-quality attributes of their end products), as long as women's access to these markets is actually facilitated through the guarantee of safe travel conditions and accurate market information. This alleviates gender constraints through improving the livelihoods of women fish processors and fishmongers.

Specifically regarding smallholder women processors and fishmongers, projects piloting the adoption of the FTT have generated a host of observations and lessons

learned, showing that when professional groups are well organized, effective and dynamic, the “economies of scale” effect greatly enhances social solidarity, livelihoods and well-being.

Moreover, the FTT not only processes the fish in a shorter amount of time but it does not entail constant handling (turning over) of the fish. This can allow women to organize their daily chores individually or as a cluster when their professional groups function properly, by sharing out the tasks while taking into account specific individual obligations and constraints.

Improving fish processors’ working conditions along the value chain can actually be perceived as a golden opportunity to promote the FTT, as it greatly reduces: the actual time necessary for the activity; drudgery; and exposure to the hazards and health risks discussed above. This technique, which can be entirely adapted to the material reality of smallholder women processors and fishmongers, provides them with more financial and personal and social autonomy as well as greater self-confidence, given that they prospectively could have easier working and living conditions.

Recommendations

- It is strongly recommended that FTT kilns be used to reduce the adverse health impact of traditional fish smoking on women fish smokers.
- When promoting the FTT, it should be highlighted that it not only greatly reduces drudgery, fire, heat hazards and health risks, and the actual time necessary for the activity, but it also reduces waste and thus enables processors and fishmongers to earn more for their efforts.
- Local studies, based on the one carried out in Côte d’Ivoire (Anoh *et al.*, 2018), showing the health advantages of the FTT for women processors and the neighbouring population should be carried out wherever an FTT unit has been provided through the government, a donor or a development project so as to further raise awareness of users, policymakers and donors, and thus lead to informed decision-making for these three groups.
- Health opportunity costs for both traditional and FTT smoking processes should be assessed as a complement to feasibility studies, showing that although traditional kilns may be less costly in the short term, users may end up using their savings to pay for medical expenses, the recurrent maintenance and replacement resources, and time, thus reinforcing the reasons to adopt the FTT from a good health perspective. Moreover, this would allow women processors to use the money for other household expenditures such as more varied and better food, and school fees, thus improving the overall well-being of the household.
- The FTT should be promoted through post-harvest fish processing platforms to mitigate upfront costs and, more importantly, to promote social assets and business competitiveness for improved sustainable livelihoods in rural communities.

ENVIRONMENTAL PROTECTION

The main and often only available energy sources for smoking food in most developing countries are fuelwood or charcoal. Indeed, FAO’s work on community forestry, agroforestry and trees outside forests considers how to: provide local people with access to sustainable sources of fuelwood; increase the energy efficiency of fuelwood and charcoal cooking systems; and improve charcoal production to lessen the pressure on natural resources (FAO, 2014).

FAO’s flagship publication, *The State of World Fisheries and Aquaculture 2018* (FAO, 2018a), states:

The ecosystem approach to fisheries (EAF) and the ecosystem approach to aquaculture (EAA) are strategies developed and promoted by FAO in recognition of the need for wider frameworks for the planning, development and management of sustainable fisheries and aquaculture, taking into consideration the effects of other sectors on fisheries and aquaculture and the effects of fisheries and aquaculture on the ecosystem. EAF and [EAA] both support the practical implementation of the principles of sustainable development, first explicitly introduced to fisheries by the Code of Conduct for Responsible Fisheries (FAO, 1995). [...] They provide a framework for considering not only the ecological, but also the social and economic aspects of sustainability and the governance context in which the fisheries and aquaculture sectors operate. (p. 120)

A number of FAO technical publications give practical guidelines on how to implement this ecosystem approach (e.g. FAO, 2003, 2005, 2009b, 2011–2017, 2012c).

As discussed in Anoh *et al.* (2018), traditional fish-smoking systems burn massive amounts of fuelwood, thus emitting large volumes of CO₂, which is known to increase the GHG effect.

As explained in Chapters 4 and 5, the FTT is more energy efficient in terms of fuel consumption, and hence exerts lower pressure on woody resources, especially mangroves. Owing to its lower fuelwood consumption, i.e. 0.8 kg as against 3–5 kg per kg of fish smoked with traditional systems, it emits small amounts of GHGs into the atmosphere and thus less pollution for a comparable amount of fresh fish. Therefore, this technology protects both fish smokers' health and the environment (Anoh *et al.*, 2018; Ndiaye, Komivi and Diei-Ouadi, 2015; Ziehi, 2016). Moreover, it entails fewer expenses for processors, thus lowering input expenses and reducing smoking costs, once the investment in the new technology has been paid off.

While traditional kilns emit levels of CO and other toxic compounds that are significantly higher than local standards (see Table 9) and recommended limits (World Health Organization, 2006), the FTT strengthens fisheries communities' adaptation and resilience to climate change by optimizing alternative fuels, such as local biomass and agricultural residues and waste, albeit with caution depending on toxicity levels, and because they may considerably affect the taste and the texture of the end product. Table 10 gives a good sample of potential fuel sources and their toxicity level.

In addition, the use of heat-retention stones, e.g. cellular concrete (formerly siporex), clay stones or bricks, reduces the quantity of fuelwood and charcoal required by about 50 percent, according to estimates (Ndiaye, Komivi and Diei-Ouadi, 2015).

The FTT has now been recognized as a safe and environmentally efficient technology that facilitates applying sustainable forestry, EAF and EAA guidelines in fish post-harvest activities, especially at the level of processing, be it by drying or smoking. This should foster improved resource management in fish-smoking areas, and facilitate reforestation activities, while reducing fuel costs for processors.

TABLE 10
Types and characteristics of fuels that have been tested with the FTT

Fuel	What is it?	How to obtain it	Estimated cost (prices fluctuate depending on context)	Toxicity Colour legend: Green: highly advised Orange: use with caution Red: avoid
Charcoal	Comes from the combustion of wood in the absence of oxygen	Purchase from local seller or self-manufactured	USD 0.4/kg	Green
Charcoal + stones	Stone (small stones with heat-retention properties such as aerated concrete – siporex) which may be used several times	Local charcoal provider Furnace or censer vendors may sell the stones	USD 0.4/kg for charcoal and USD 0.5/kg for aerated concrete	Green
Coconut shells	Woody timber, gives more flame than coconut husks, no toxicity found	Collection/purchase	USD 2/20 kg bag	Green
Coconut husks	Woody timber, no toxicity found	Collection/purchase	USD 2/20 kg bag	Orange
Rice hay	Non-wood fibres, devoid of colour pigments. Research results have not shown any toxicity	Collection/purchase	USD 3/20 kg bag	Green
Millet stalk and hay	Non-wood fibre, roughage for ruminants as they are rich in dry matter, cellulose and energy	Collection/purchase and mainly transport	USD 2-3/20 kg bag	Green
Filao wood	Resinous ¹ hardwood	Collection/purchase	USD 0.2/kg	Orange
Dimb wood	Non-timber hardwood – gives high flames	Purchase	USD 0.2/kg	Red
Corn cob and corn straw	Non-wood fibre, rich in xanthophyll pigments ² (17 mg/kg dry matter), widely available and very effective for the golden colour desired by many consumers in smoked products. Toxicity found in the straw could be related to its high content of phenolic acids ³ active even at low concentrations	Collection/purchase	USD 3/20 kg bag	Orange
Butane gas	Butane gas cylinder	Purchase	USD 8/6 kg cylinder	

¹ Resinous wood: qualified as such because the sap produces resin or gum.

² Xanthophyll pigments: pigments that make plant organs yellow.

³ Phenolic acids: phenolic acid is an organic compound having at least one carboxylic function and one phenolic hydroxyl.

Note: Using recycled wood (treated and painted) is not recommended as it has toxic effects.

Source: Ndiaye, Komivi and Diei-Ouadi (2015).

In parallel to this recognition, benefits derived from the FTT could be further enhanced through the adoption of green energy sources. In fact, as underscored by the International Renewable Energy Agency (IRENA) (cited in Peñarubia, Randrianantoandro and Diei-Ouadi, 2018), Africa has huge renewable energy sources, particularly solar energy and biogas as well as geothermal energy. This has been proved from several national resource assessments for one or more renewable energy sources, while solar and wind assessments have been conducted in 21 countries, biomass assessments in 14 countries, and geothermal assessments are under way in 7 countries.

Solar energy can be used at different scales from household and community levels to industrial and national levels of operation. [Its] production has the potential to exceed future demands. [...] Solar energy is currently employed for the NIOMR oven in Nigeria and also emerging in initiatives/projects centred on the FTT-Thiaroye. If the use of solar energy in cooking the fish is proven effective, it can also be applicable to other ovens. (p. 340)

Africa can also develop and utilize its immense potential in biogas as a renewable energy from anaerobic digestion of fish and fish waste, thereby providing many environmental, social, economic and health benefits to fisherfolk, consumers and the community as a whole. IRENA (cited in Peñarubia, Randrianantoandro and Diei-Ouadi, 2018) states that

This type of energy has added benefit of being able to produce a consistent 'base-load' source of power or the minimum level of demand on an electrical grid over a span of time, rather than just when the sun shines or the wind blows. Organic material is required to produce biogas and is available in a wide range of forms on the African continent. Possible source of biogas are dumpsites (landfill gas), human waste (sewage gas), from household waste or agricultural materials and naturally occurring biogas. In Africa, the estimated potential for biogas is significant, with 18.5 million households having sufficient dung and water, primarily in rural areas. Several programmes are in place in Africa to increase the use of biogas in domestic applications.⁸ [...] (p. 340)

Household waste can be collected from and become potential source of food for anaerobic microbes. These microbes feed off carbohydrates and fats, producing methane and carbon dioxides as metabolic waste products. This gas can be harnessed by man as a source of sustainable energy. As there are many potential sources of materials for biogas, the use of this renewable energy does not drive food waste at consumption level. Rather, the technology is encouraging to reduce waste by using it to process and preserve perishable food materials. (p. 341)

All of these different sources of energy should be tested with the FTT for the cooking phase, as this would further the use of fuelwood, which would only be used for the actual smoking phase.

Recommendations

- The use of the FTT should be promoted to minimize environmental impacts.
- Where FTT units have been or are to be installed, a study should be carried out to examine what renewable energies are readily available and what are the potential ones to then develop a reliable and easily usable green energy source for the cooking phase, and potentially for powering these units as a whole in terms of refrigeration, storage facilities, lighting, etc.

FINANCIAL AND ECONOMIC BENEFITS

A recent study (Mindjimba, 2017a) conducted in Côte d'Ivoire not only confirmed the comparative advantages of the FTT *vis-à-vis* other fish smoking systems (be they traditional or improved), it also demonstrated the financial and economic profitability of this new system as follows:

- With an upfront investment of USD 1 419 using either one FTT kiln prototype (namely a double-compartment FTT Banda prototype) or USD 4 709 for several prototypes installed on the two platforms at Abobo-Doumé and Guessabo (which included two double-compartment Banda prototypes and a double-compartment FTT Altona prototype), the net present value amounted

⁸ An example of such programmes is the Africa Biogas Partnership Programme, which operates in Burkina Faso, Kenya, Ethiopia, Uganda and the United Republic of Tanzania (IRENA, cited in Peñarubia, Randrianantoandro and Diei-Ouadi, 2018).

to USD 17 133 and USD 12 636, respectively. This corresponds to an internal rate of return of 34.9 percent and 31.7 percent, respectively, based on a discounting rate of 10 percent over a period of 10 years. Although this upfront investment may seem high for smallholder fish processors supplying domestic or regional markets, study findings revealed that it could be paid back in less than 12 months. Moreover, the tangible benefits of the FTT outweigh its cost, especially when more lucrative international markets (such as the markets of the European Union) or even specific domestic niche markets are targeted.

- FTT platform growth in terms of added value onto fish and fishery products (Table 11) – In 2015, activities performed by Women Fish Traders and Processors Cooperative of Abidjan (CMATPHA) on the FTT platform in Abobo-Doumé (fish processing and trade, sale of food packaging materials and washbasins alone) using a typical FTT kiln referred to above produced a gross added value of USD4 025 (from a turnover of more than USD 17 775 and an intermediate consumption above USD 13 750).
- The same year, CMATPHA members mobilized more than USD 78 400 of internal savings, which earned an interest of almost USD 4 030 for the cooperative.

TABLE 11
Value added from smoking fishery products and income-generating activities with a typical FTT kiln on the Abobo-Doumé platform, Côte d'Ivoire, in 2015

ID	Parameters ¹	Amount USD ²
1	Turnover from sales	
1.1	Sale of smoked fish	14 091
1.2	Sale of food packaging materials	1 397
1.3	Sale of washbasins	2 287
	Total 1	17 775
2	Intermediate consumption	
2.1	Cost of fresh fish to smoke	9 446
2.2	Cost of fuels	325
2.3	Cost of water to wash fresh fish prior to smoking	27
2.4	Cost of food packaging materials	1 034
2.5	Cost of washbasins	1 900
2.6	Loading and transport of raw materials (fresh fish and washbasins)	240
2.7	Labour (scaling of fish)	273
2.8	Fish self-consumed or gifted	472
2.9	Loss (washbasins)	33
	Total 2	13 750
	Gross added value	4 025

¹ The analysis does not include all running and exceptional costs and benefits, personnel charges and allocation for depreciation. These items are accounted for in the business plan and financial profitability appraisal.

² At an official exchange rate of USD 1 for CFAF 604.2296 on 31 December 2015 [online]. [Cited 10 October 2018]. <https://fr.exchange-rates.org/Rate/XOF/USD/31-12-2015>

Source: Mindjimba (2017a).

- From the public health viewpoint, as indicated above, women fish processors using the FTT are less prone to occupational diseases. The associated cost of treatment of such diseases has been estimated at about USD 1 250 annually per patient in terms of medical advice and hospital care (and hence bills). This represents an opportunity cost resulting from the use of traditional fish smoking methods but which fish smokers will no longer incur from their shift to the FTT.

- Contribution to local trade and economy through purchase of raw materials and inputs or intermediate consumption, sale of good-quality and safe products.
- Creation of ancillary jobs for local artisans (e.g. carpenters, blacksmiths, welders, masons, trimmers and cutters) to craft FTT components using local materials.

A cost–benefit analysis conducted in Sri Lanka in July 2016 (Rotawewa and Wickramasinghe, 2018) revealed that women fish smokers’ low average monthly income of USD 73 resulted from low profit margins and poorly marketable darkened product, leaving them and their households ultra-poor and vulnerable. Improved quality and throughput of products from the pilot FTT project ensured selling opportunity in the supermarkets in large cities and boosted processors’ monthly incomes to USD 340, as shown in Table 12.

TABLE 12
Cost–benefit analysis comparison between traditional and FTT smoked products in Sri Lanka

Item	Amount per smoking technique			
	Traditional		FTT	
	LKR	USD equivalent	LKR	USD equivalent
Income per month during peak season	15 800	105	73 333	489
Average monthly income based on seasonal fish catch fluctuation	10 990	73	51 000	340

Source: Rotawewa and Wickramasinghe (2018).

In sum, as explained in Chapter 5 and the preceding sections, in comparison with traditional fish-processing systems, the FTT consumes less fuelwood. In addition, it reduces PHFL along the value chain while enhancing the holding capacity of the kilns by 3–15 times; it yields safer (with regard to PAH and metallic trace elements [MTE] levels in particular), higher and more uniform quality (in terms of colour, appearance, texture, taste, smell and shelf-life) and more competitive products, thereby improving economic productivity (leading to higher processors’ incomes) and food security.

CONCLUSION AND WAY FORWARD

The FTT’s multiple benefits described above can only become a reality if all actors concerned clearly understand and agree on these. This calls for a well-thought-out process with a step-by-step roadmap. Prior to the government, a donor or a development project providing any infrastructure or technology, the following steps should be implemented:

- Carry out local studies, based on the post-harvest loss assessment (PHLA) methodology and the assessment of fish-smoking processors’ health status done in Côte d’Ivoire.
- Implement awareness building and capacity strengthening in functional literacy, business planning, the concept of added value, the benefits of good hygienic and handling practices, the FTT, packaging, storage practices, and complementary revenue activities. These should be complemented by different dissemination channels such as local radio (Dimitra Programme, etc.), posters in markets, exchange visits to well-functioning platforms or other community-managed infrastructure with good and efficient group cohesion.
- Assess existing local professional groups and evaluate what is necessary to transform them into highly beneficial institutions for their members. Much can be gleaned from Herbel *et al.* (2012) on these aspects.

This will truly enable actors along the post-harvest fish value chain to take ownership of the FTT. It will also provide policymakers and donors with realistic and accurate information, and thus lead to inform coherent decision-making regarding allocation and implementation of this technology and inform policy processes. At present, certain bilateral donors have gifted fish landing platforms that include kilns equipped with FTT technology without first conducting a needs assessment or ownership building, professional group cohesion and efficiency activities. Unless national governments implement accompanying measures and activities, this could result in white elephants (Abidjan.net, 2017). This is further discussed in Chapter 9.

Chapter 7

Trade-offs and challenges

INTRODUCTION

The FTT demonstrably offers great promise for protecting public health, underpinning livelihoods, increasing incomes of (smallholder) fish processors, boosting foreign earnings from international trade, and supporting global efforts at sustainably protecting the environment. The benefits discussed present strong arguments for the adoption of this new technology. However, it is important to examine the contextual factors that may affect how the gains associated with its use could be realized without making rather expensive compromises. How, for example, will access to hitherto inaccessible more rewarding markets for smoked fish influence the pressure on natural resources? Will smallholder fish processors be ready to invest in improved kilns that cost more than the traditional options? What kind of support will these processors need from government, and how should it be delivered? How readily will consumers accept fishery products that are said to be safer but may look different from those they are used to? Can the current state of fisheries and aquaculture in any country trigger the adoption and widespread dissemination of the FTT without compromising the health and integrity of the ecosystems and its resources? Moreover, how will the adoption of an improved kiln influence trade dynamics in smoked/dried fish? This chapter discusses potential trade-offs that may be associated with the adoption of the FTT, including compromises between increased fish export versus domestic fish food security, high fish prices driving overfishing, and high farmed fish prices driving consequences for ecological sustainability, among others.

STATE OF FISHERIES AND AQUACULTURE WITH REGARD TO FURTHER DISSEMINATION OF THE FTT

As detailed in the following paragraphs, global capture fisheries have practically reached their maximum sustainable yield. Thus, prior to locally promoting the dissemination and scaling-up of the FTT, countries need to understand the volume and health status of their fisheries resources and their capacity to produce eco-friendly and responsible aquaculture resources. Under no circumstances should the introduction of this technology foster illegal, unreported and unregulated (IUU) fishing. Hence, as discussed in Chapter 2, an in-depth assessment of existing resources should always be conducted. Moreover, frozen fish imports should be kept at a level that does not threaten the country's balance of payments. The ministry responsible for fisheries should work hand in hand with the national statistics institute to inform decision-making on new FTT units and issuing processing accreditations.⁹ Most probably, a viable and thriving aquaculture sector may need to be flourishing before widely disseminating the FTT.

According to available statistics (FAO, 2016a, p. 10), "in 2014, 13 out of the 25 major fishing countries increased their catches by more than 100 000 tonnes compared with 2013 [...]. The most significant increments were those of China, Indonesia and Myanmar in Asia, Norway in Europe, and Chile and Peru in South

⁹ This is equivalent to a fishing licence, establishing a private FTT platform.

America.” Moreover, “in many instances, fishery resources have been unable to sustain an uncontrolled increase in fishing accompanied by ever-increasing sophistication in fishing technology.” (p. 83). The same source further states:

In the coming decade, capture fisheries production is projected to remain rather stable. However, the real prospects for capture fisheries are rather difficult to determine because they depend on the natural productivity of fish stocks and ecosystems, and are subject to many variables and uncertainties. Moreover, illegal, unreported and unregulated (IUU) fishing and the overcapacity of fishing fleets globally are other important threats affecting the sustainability of fisheries resources. (p. 80).

With most fishery stocks expected to remain maximally sustainably fished (formally termed fully fished) or overfished for at least the next decade (FAO, 2018a), marine and inland capture fisheries cannot be expanded.

At present, as detailed in Chapter 8, the FTT has been, or is about to be, introduced in 23 countries (21 in Africa and 2 in Asia). Tables 13 and 14 present volumes of fish available for human consumption, showing that Africa will not be able to expand its capture volume or imports to meet consumer demand unless there is a complete reversal of pollution levels and fish stock trends (see Chapter 2) and that the continent needs to carefully assess how to ensure expanding aquaculture activities. Asia, which is the largest producer of fish, both for capture fisheries and aquaculture, may not be in a position to continue to export more than one-third of its production, unless it expands its aquaculture yields. Ecological consequences are not to be ignored, as they could bring about health issues for fish, humankind and nature as a whole that may be disastrous.

TABLE 13
Africa and Asia – share in world fisheries production, 2015

	World		Africa		Asia	
	Volume	Volume	Percentage	Volume	Percentage	
Inland captures	11 465 775	2 860 131	24.9	7 582 037	66.1	
Marine captures	81 164 685	5 933 859	7.3	43 106 562	53.1	
Aquaculture	76 599 902	1 772 391	2.3	68 392 709	89.3	
Total	169 230 362	10 566 381	6.2	119 081 308	70.4	

Source: FAO Yearbook 2015 (FAO, 2017c).

TABLE 14
Africa and Asia – share in world fisheries imports and exports, 2015

Subsector	World		Africa		Asia	
	(USD thousand)	(USD thousand)	Percentage	(USD thousand)	Percentage	
Imports	127 573 496	5 250 695	4.1	41 630 591	32.6	
Exports	133 244 854	6 019 604	4.5	51 766 268	38.9	
Balance	567 136	768 909		10 135 677		

Source: FAO Yearbook 2015 (FAO, 2017c).

As illustrated in Figure 24, population growth projections show that Africa and Asia will continue to have the most rapid expansion, which will require all food suppliers to keep pace with the rising number of people. Moreover, from 2017 to 2050, it is expected that half of the world’s population growth will be concentrated in just nine countries: India, Nigeria, the Democratic Republic of the Congo, Pakistan, Ethiopia, the United Republic of Tanzania, the United States of America, Uganda and Indonesia (ordered by their expected contribution to total growth). India, Nigeria, the United Republic of Tanzania, and Indonesia are countries that could reap greater benefits from

the expansion of the FTT given their current processing methods, the fact that they produce a fair quantity of smoked fish and that their population may not have access to a reliable cold chain.

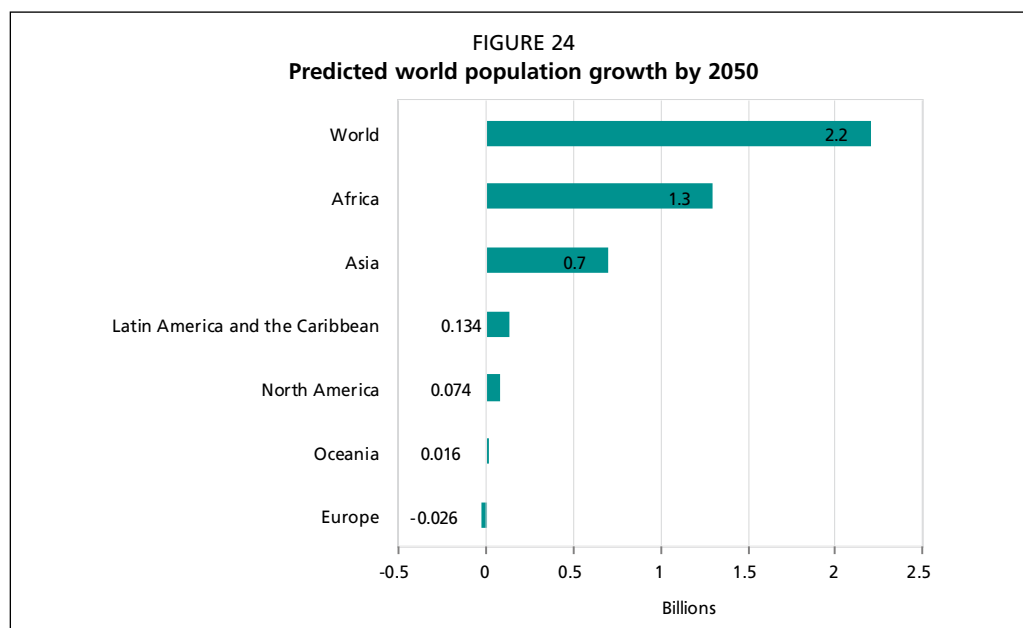

Sources: Kazeem (2017); UNDESA (2017).

Tables 13 and 14 and Figure 24 confirm that, as stated above, should countries or post-harvest fisheries actors in the private sector decide to adopt or disseminate the FTT, there will be a need to assess not only existing resources, sustainable and eco-friendly aquaculture potential and the possibility of using frozen fish imports, but also current fish losses and their reduction potential and projections over time. Fish food sovereignty at country or regional level may be key to ensuring protein sufficiency for the population.

Therefore, further dissemination of the FTT should be preceded by preliminary cost-benefit and feasibility studies with projections on the probable impact of increased fishing activities that take into account medium- to long-term ecological consequences, so as to ensure economically viable and successful enterprises.

UPFRONT INVESTMENT AND THE CREATION OF AN ENABLING BUSINESS ENVIRONMENT

The upfront investment, the anticipated return on investment and the inherent risks are probably the top criteria that a rational investor will consider when making a decision as to whether to venture into a business or a set of activities or not. As outlined in Chapter 6, the benefits of the FTT and its comparative advantages *vis-à-vis* other fish processing methods are not only financial and economic, they are also nutritional, sanitary, environmental and social in nature. Thus, the decision to invest in this new technology transcends the mere financial criterion to embody the other no-less crucial criteria, especially in the context of developing countries. In fact, these countries are characterized by structural limitations of their SSF and the impoverishment of their populations, who form the bulk of consumers of smoked and dried fish compared with high- and middle-income populations. This section examines the upfront investment required for any FTT initiative to guide the decision-making process, particularly in terms of sector policy.

As reviewed below, the upfront investment of the FTT depends on various factors, including the prototypes (Altona, Banda or Altona), their number, dimensions and specifications. The warehouse or shed is another cost factor to consider. The pilot FTT kilns and platforms in Côte d'Ivoire provide illustrative examples in this regard (Tables 15 and 16).

As seen, the upfront investment varies from USD 381 (for one cooking-compartment Chorkor) to USD 1 668 (double-cooking compartment Banda).¹⁰ Total investment for all FTT kiln prototypes installed on a platform amounts to USD 4 709 and almost USD 21 260 when the cost of the warehouse is included (Mindjimba, 2017a). In comparison, the FTT unit (kiln and shed) installed in Unnichchai fishing village, Batticaloa District in Sri Lanka cost about USD 1 440.¹¹ This investment may seem to be beyond the reach of the average smallholder fish processor in SSA and Asia. To date, the existing FTT interventions across the country case studies under review have been funded either entirely by development agencies or jointly with government agencies. Therefore, the challenge is how to make sure that smallholder fish processors can invest in the FTT without external funding.

TABLE 15
Upfront investment in FTT components in Côte d'Ivoire, as of 31 December 2015

Item	Quantity per FTT kiln prototype					Unit cost (USD) ³	Lifespan (years)
	2 cc ¹ Banda	1 cc + 1 cf ² Banda	1 cc Altona	1 cc + 1 cf Altona	1 cc Chorkor		
Masonry	Lump sum	Lump sum	Lump sum	Lump sum	Lump sum	393786	10
Lid	4	4	–	–	–	39–157	12
Tray	4	4	6	12	6	19–28	3–5
Ember furnace	2	1	1	1	–	348	5
Fat- collection tray	2	1	1	1	–	166	5
Smoke generator	–	1	–	1	–	265	5
Door frame	–	–	2	2	–	58	12
Paint	Lump sum	Lump sum	Lump sum	Lump sum	Lump sum	25–50	1

¹ cc = cooking compartment.

² cf = smoking compartment.

³ At an average official exchange rate of USD 1 for CFAF 604.2296 on 31 December 2015.

Source: Jean M. Monney, personal communication, 31 December 2016.

TABLE 16
Upfront investment of FTT kilns in Côte d'Ivoire, as of 31 December 2015

Platform sites	FTT kiln prototype	Unit cost	Total cost	Average cost of warehouse (USD) ³	Total cost of platform
Braffedon & Marcory-Anoumabo	2 cc ¹ Banda	1 668	4 664	16 550	21 214
	1 cc + 1 cf ² Banda	1 419			
	1 cc Altona	1 196			
	1 cc Chorkor	381			
Abobo-Doumé & Guessabo	2 cc Banda	1 668	4 709	16 550	21 259
	1 cc + 1 cf Banda	1 419			
	1 cc + 1 cf Altona	1 622			

¹ cc = cooking compartment.

² cf = smoking compartment.

³ At an official exchange rate of USD 1 for CFAF 604.2296.966 on 31 December 2015.

Source: Jean M. Monney, personal communication, 31 December 2016.

¹⁰ Note that the upfront investment costs mentioned in this section refer to the lowest and highest, whereas those presented in the section pertaining to the financial and economic benefits of the FTT (Chapter 6) are those Mindjimba (2017a) used to determine the financial and economic profitability of this new technology.

¹¹ At the exchange rate of USD 1 for LKR 157.7588 on 17 May 2018.

This trade-off factor of upfront investment can be addressed from a financial perspective, but more importantly also from a broad policy perspective. In fact, more effort needs to be made to improve the enabling business environment with a view to promoting investment that fosters tailored microcredit and savings systems as well as the emergence of local financiers. Moreover, social measures and safety nets should be mainstreamed in sector programmes and projects while deterring the dependency syndrome.

There is also a need for more stakeholder and community engagement in terms of shared contribution (in cash or in kind through the provision of plots of land, materials, equipment and labour) towards the establishment of FTT units. Attracting and maximizing investment in fisheries value chains can indeed improve the lives of hundreds of thousands of poor people in SSA and Asia, who mainly depend on the sector for their livelihoods. As discussed in Chapter 8, it is governments' responsibility to create such an enabling environment.

CONSUMER ACCEPTANCE OF FTT PRODUCTS

The well-established food safety benefits of the FTT notwithstanding, its adoption in any context will depend critically on the downstream acceptance of its products. In general, sensory attributes of food products such as colour, texture, aroma and taste affect their acceptance by consumers. For hot-smoked fish, there appears to be a cultural perception of an association between the colour of the product and its quality: the darker, the better. During a plenary discussion in a seminar on the results of studies on the FTT at the University of Ghana,¹² some smoked fish processors asserted that retailers complained when smoked fish were not dark in colour. To them, smoked fish must look smoked; the "smoked appearance" being a dark colour. At the same seminar, a smoked fish exporter who uses a modern kiln fuelled with butane gas indicated that his products were not accepted by some segments of the Ghanaian market because of their "paleness". Similar observations were made in Côte d'Ivoire, the Republic of the Congo and the United Republic of Tanzania where, in comparison with smoked fish from traditional kilns, FTT products were considered to be pale and hence less appealing (Mindjimba and Tiotsop, 2018).

Therefore, it seems that the cultural attachment to dark-coloured smoked fish calls for sensitizing the public at large on the relationship between the darkness and the reasons for which smoked products are dark (in reality the degree of tar deposits on the fish), their lack of food safety, and the health implications for consumers.

Consumer acceptance of FTT products was evaluated in Ghana at two levels (Bomfeh *et al.*, 2018). The first evaluation determined what differences, if any, consumers could identify between smoked-soft fish from the FTT and the Chorkor smoker. The second evaluation determined which product, in light of what differences might have been recorded in the first assessment, was preferred.

Between FTT and Chorkor products, noticeable differences were identified in the colour (FTT products were lighter in colour) and texture (Chorkor smoker products were softer). Attributes such as aroma and flavour were found not to differ significantly. These suggest that product colour and texture were likely to be important determinants of consumer preference. However, further preference tests showed no significant differences between the degrees of liking for the products. Hence, although FTT and traditional kiln products differed in appearance and texture, the differences

¹² This one-day seminar was organized in September 2017 jointly by the University of Ghana, Ghent University and the FAO Regional Office for Africa to disseminate and discuss the findings of studies on the safety and consumer acceptance of FTT products in Ghana. It drew participants from women fish processing and trading associations, academia, research institutions, smoked fish exporters, non-governmental organizations (such as SNV Ghana and USAID Ghana) and the general public.

were not of such a magnitude as to swing consumer preference. Thus, on the basis of the test attributes, the findings suggest that consumers will accept FTT products.

Therefore, it is probable that public education both on the health challenges associated with consumption of smoked fish from traditional kilns and on the protection afforded by the FTT in that regard will contribute to efforts aimed at promoting the adoption and sustained use of the technology.

THE NEED FOR LIVELIHOOD-SENSITIVE COMMUNICATION ON THE BENEFITS OF THE FTT AND THE CHALLENGES OF TRADITIONAL KILNS

While, as the risk assessment data show, smoked products from traditional kilns pose public health challenges, it is important to avoid communicating the facts in a language that demonizes the products and the hardworking processors (most of whom are women) who, by their activities, provide crucial support for food security and nutrition and obtain their livelihoods thereby. A media report in Nigeria carried the headline “Expert warns Nigerians against eating locally-smoked fish” (Metrowatch, 2015). This was in connection with an apparent public education initiative on the benefits of the FTT-NIOMR *vis-à-vis* low PAHs. Similarly, in Ghana, after the findings of the comparative PAH assessments of traditional kiln and FTT products were shared at a public seminar, some media platforms emphasized the sensational aspect that Chorkor smoked fish can cause cancer (Ofori, 2017). Such communication could cause scaremongering among consumers, with direct adverse implications for FSN, PHL and the livelihoods of smoked fish processors and fishmongers. Therefore, it is important to ensure that advocacy messages on the FTT underscore the positive note that it is an improvement on traditional kilns for the benefit of all stakeholders.

MARKET ENVIRONMENT AND ACCESS

Consumer demand and preferences

People have never consumed as much fish as they do today, with per capita global fish consumption having doubled since the 1960s. Of all animal protein commodities, fish and fishery products are among the most traded in terms of value (more than 35 percent of the fish produced is traded internationally). Trade pressures and market demand and choices, especially those of the most affluent countries, greatly influence the choices of fishery and aquaculture producers worldwide, even in very remote regions. This trade flow is particularly important for developing countries, which accounted for 59 percent of world exports and 46 percent of world imports of fish and fishery products in 2016, by quantity (in live weight equivalent) (FAO, 2018a). This means that the related issues of where, when and how fish is traded become extremely important in terms of ensuring FSN. The challenge is greater in poor areas where fish is an affordable source of essential nutrients, and in coastal populations where fish is a major source of animal protein and micronutrients (FAO, 2014).

One market research report (Technavio, 2017) predicts that the global smoked fish market will grow at a compound annual rate of almost 8 percent to USD 21.07 billion by 2021, with per capita consumption of fish and seafood increasing by 3 times in developing countries such as China and India. Factors such as the growing global population, increasing disposable income, and rising awareness about the health benefits of consuming seafood, have led to the rise in demand for fish and seafood across the globe, spurring market growth. Moreover, aquaculture production expansion is proportional to the increase in demand and is anticipated to supply more than 60 percent of overall global fish and seafood demand by 2030 (BusinessWire, undated).

The report also states that one of the latest trends gaining traction to respond to market demand is the adoption of new techniques for smoking fish, and that manufacturers are developing innovative technologies, such as the FTT to improve the quality and taste of smoked fishery products. Figure 25 shows some of elements that

will induce this growth, including utilizing new packaging and promoting good-quality processed, ready-to-eat smoked fishery products – that can be new to consumers – on different markets.

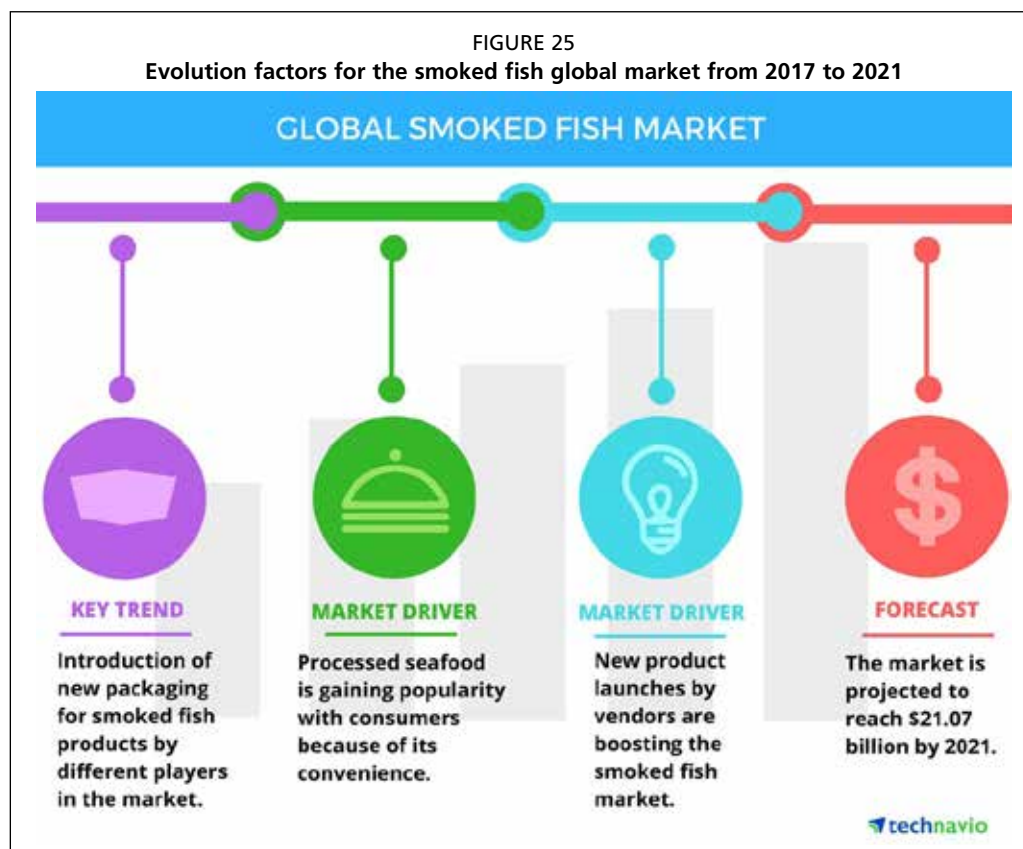

Source: Infront Research Limited, London.

<https://www.technavio.com/report/global-food-global-smoked-fish-market-2017-2021>

However, for many consumers in low- and middle-income countries, nutritious foods including fish may be unavailable or unaffordable, creating nutritional problems. Consumers around the world face the issue of food choices constrained by supply, access, price, information, diversity, safety and quality. Food-related consumer behaviour and decisions are very complex, and they are influenced by a multitude of factors such as food habits, societal norms, income allocation, market conditions and the information environment. Consequently, many consumers make food choices that are inconsistent with providing them with good nutrition, health and well-being (Global Panel, 2017). Given that, as indicated above, fish smoked with the FTT has a longer shelf-life (up to six months, according to Ndiaye, Komivi and Diei-Ouadi, 2015) when it is properly smoked and adequately packaged and stored while remaining relatively inexpensive, it is essential to better understand consumer preferences and market dynamics so as to promote its consumption and thus improve low-income consumers' diets and nutrition.

The following paragraphs give a sample of what may be found in terms of existing scientific information on consumer preferences and market conditions regarding smoked fish in selected geographical areas.

In Angola, consumers prefer fresh freshwater fish, followed by smoked fish while salt-dried and frozen fish are the least desired (Mindjimba, 2017b).

A recent study (Akoun, 2018) conducted in Burkina Faso showed that, although the FTT has been adapted for local Dafing kilns, an information campaign has yet to be launched to provide caterers (restaurants, street stalls and hotels) and consumers

with the description of the advantages of the new fishery products. Notwithstanding this, consumers with a monthly income of about USD 94 are willing to pay more for smoked fish when it meets three criteria:¹³ (i) a pleasing taste and a good texture for preservation (the fish must be dry); (ii) the size of the fish; and (iii) better packaging.

Consumers in certain parts of African countries spend more on fish than on any other food, as for example in Kumasi, Ghana, where the budget share for fish for urban and rural households is 28 percent and 27 percent, respectively, with 68 percent of households consuming fish more than 8 times a month. However, price is a significant factor, and households with children are more likely to purchase smoked rather than fresh fish, as it might be perceived as safer (Gebrezgabher, Amewu and Amoah, 2015). The SNV Netherlands Development Organisation has been playing an important role in improving food safety awareness by educating consumers about potential risks associated with smoked and dried fish, training fishmongers on improving technology and sanitary conditions and introducing fish processors to the FTT.

In Eastern Africa, dried fish is often of low quality, restricting sales of that commodity to low-income groups shopping at open-air markets. At the same time, there is increasing demand among middle-class consumers for high-quality dried and smoked small fish to be available in outlets such as supermarkets. In Kenya, the only dried and smoke-dried fish packaged is that sold in supermarkets, which is a small portion of the total production available domestically (Odoli, 2015).

In a survey carried out in the Mwanza Region of the United Republic of Tanzania (Salehe *et al.*, 2014), consumers did not have a significant preference for processed products in the form of fish balls, fish pie, fish samosa and hot-smoked fish from tilapia and catfish, while almost 80 percent of respondents indicated that they preferred tilapia over African catfish, and only 9 percent preferred the latter species. This indicates that consumers are willing to purchase processed fish products from less-valued fish.

In Asia, fish is also preserved through drying or smoking. In the Bundelkhand Region of India, low-income households generally buy smoked local low-value fish, while others are partial to buying carps, preferably local fresh fish. The smoked fish is usually sold in local retail markets rather than wholesale ones by women fish processors. They carry the smoked fish on their heads, selling it in local daily or weekly markets to low-income consumers (Vrutti Livelihood Resource Centre, 2008).

In Indonesia, fish accounted for more than 60 percent of the animal protein consumed in 2004 (Kusumastanto, 2004). According to household surveys conducted in 2014 (Needham and Funge-Smith, 2014), marine fish accounted for more than 70 percent of consumption, and inland species for some 25 percent. Although Indonesia is an archipelagic country with a long coastline, it also has enormous freshwater resources, and its inland fisheries production is very substantial, particularly in the hinterlands and especially in Kalimantan. Inland fish were a much higher percentage of the fish consumed in Central and South Kalimantan and West Java (33–36 percent). At the nationwide level, most fishery products (70 percent by weight) are consumed fresh while 30 percent are eaten as preserved or processed products. There were no observable large differences between the types of fish consumed in urban and rural areas, nor the quantity of fish consumed. The 2015 FAO per capita actual supply figure of 31.8 kg is more than double the 12.8 kg figure derived from the household surveys. This can partially be explained by the fact that up to 30 percent of the fish consumed is processed in some way, and thus has a lower weight than fresh fish. Moreover, not all production is sold. Fish smoking seems to be small-scale and with traditional methods, and yet the market is there, given that Indonesians consume 30 percent of their fish processed. They favour the distinctive flavour obtained through hot-smoking

¹³ At the exchange rate of USD 1 for CFAF 532.97 on 30 March 2018 [online]. [Cited 10 October 2018]. <https://fr.exchange-rates.org/Rate/USD/XOF/31-03-2018>

(Junianingsih, Hakim and Harahab, 2014), meaning that the introduction of the FTT in this country could have a positive impact on the activity and on health concerns. More information is needed on who produces smoked fish, where it is sold, and on handling and storage practices (Needham and Funge-Smith, 2014).

All these studies show that smoked fish is popular or favoured in many African and Asian countries where both freshwater and marine fish are processed.

Drivers and gaps for meeting market requirements in developing countries

Overall, trade policies implemented by countries – including tariffs, subsidies and non-tariff measures such as food safety and sustainability standards – significantly shape fisheries production and trade, particularly with regard to access to international markets, as demonstrated in the case of the FTT. While many trade measures have legitimate objectives, some of them, including private standards, traceability requirements, higher tariffs for products with added value and certification requirements, can create technical or financial obstacles and restrict market access (FAO, 2018c).

For decades, technology around fish drying and smoking activities in developing countries has been driven by development partners, which have sought to improve efficiency that will lower waste and GHG emissions, and preserve natural resources, be they aquatic or the wood used for hot smoking. Although some studies have been conducted on consumer preferences, little investment has been made in SSF to meet international requirements or prevent existing and potential health issues.

For example, in 2000, the hot-smoked fish to be exported from the Gambia by air to ethnic markets in Europe and the United States of America was chilled, wrapped in a plastic film and packed in polystyrene boxes (Njai, 2000), but the products were not checked for compliance with food safety standards, whether they were sold on the domestic market or shipped out of the country. However, as discussed in Chapter 6, African hot-smoked fish exports to the market of the European Union were brought to a halt when the European Union (Member Organization) set its standards, and African hot-smoked fish merchandise did not comply with the 2006 regulations of that organization. This triggered further applied research to devise a hot-smoking system that could help generate products that comply with the standards of the European Union, and it resulted in the design of the FTT.

In 2011, semi-industrial fish processing enterprises in Côte d'Ivoire and Togo started to use this new technique to process fish for the European market, and they have been successful in accessing these more buoyant markets again.

This reflects a current widespread approach throughout the international development community and national development decision makers. These actors have given lower priority to existing local markets in terms of improving substandard producing and processing practices, understanding complex consumer needs and demands from social and health perspectives, and balancing flavour, taste and aroma preferences and products that fit the highest food safety and nutrition standards, compared with enhancing production modelled on western conventional agriculture, livestock and fisheries practices, which are now being questioned by institutions such as FAO (FAO, 2017d, 2018d).

Although immediate economic rates of return are part and parcel of every production development initiative, these rates of return regard actors along the supply chain, but rarely include the medium-term effects on the environment and never those on consumers. The FTT studies conducted to date are no exception in this regard. This has a great impact on what is found on domestic markets and in terms of consumer protection compliance and the awareness levels of producers, processors and consumers. There is a need to honour international and regional commitments to the right for all to good-quality food for FSN.

Moreover, middle- to high-income classes are expanding in Africa and Asia, and are thus in a position not only to easily be more aware of healthier food consumption choices but to also afford higher-quality goods (FAO, 2016a). They may well request higher-quality smoked fishery products, especially if local services and retailers can guarantee their safety and quality. This would have a multiplier effect on the earnings of SSF actors, and more particularly on women processors and fishmongers. In addition to local populations, the African and Asian consumers forming part of the world diaspora should also be taken into account. As stated in one example (Burrows, 2012), Nigeria, the most populous African country could see its per capita incomes treble by 2030, lifting 80 million people out of poverty, if it collects its demographic dividend in full. Part of that economic success would involve experiencing continued high levels of migration as young Nigerians emigrate to acquire or hone their skills abroad before returning. These temporary migrants form part of the diaspora of imported smoked- and dried-fish consumers in Europe and North America.

Marketing challenges

In order to address marketing challenges, national food regulations and health standards compliance schemes should be introduced, and government personnel should be endowed with adequate capacity and infrastructure to ensure laboratory and inspection services.

As stated above, in most contexts, women constitute the majority of smallholder fish processors and are often the sole smallholder fish smokers (Rosenthal, forthcoming). Women smoked-fishmongers are also more numerous, and men tend to be involved in larger-scale fish trade. Throughout West Africa, smallholder women fish smokers and fishmongers have less access to profitable markets and mobility, financial capital, market information, well-managed professional organizations, and high-value fish species.

For example, in the Western Region of Ghana, as in the rest of the country, women are dominant in traditional fish processing and trade in both large- and small-scale operations. With the exception of some remote producing centres where experience in some Volta Basin areas demonstrated otherwise (Diei-Ouadi *et al.*, 2015), most women processors do not wait for fishmongers to come to them – they actively seek market opportunities by transporting smoked fish to various large markets within and outside their district or region of origin. In these markets, processors are excluded from selling directly to consumers (Gordon, Pulis and Owusu-Adjei, 2011). Some processors in Ghana also send their products directly to wholesale. This is the case of some women fish processors in Accra who send their smoked-dry fish by themselves to Techiman (a major fish market about 370 km from the capital Accra, entailing a travel time of about 7 hours) for sale. There are also cases where some women travel for days or weeks to sell their products on such markets.

In the post-harvest fish loss assessment (PHFLA) conducted in Ghana in August 2013, fishmongers reported a rise in recurrent attacks or robberies, creating a climate of insecurity that led to a drastic reduction in fishmongers travelling to fish markets located close to inland fishing sites, thus slowing the pace of trading activities, and leading to “artificial gluts” with subsequent high records of losses due to market forces and seriously affecting the livelihood of fisheries communities (Diei-Ouadi *et al.*, 2015).

A survey conducted in Ekpoma, Edo State, Nigeria (Obasohan, Edward and Oronsaye, 2012), showed that catfish processing and retailing in the area was done entirely by women, where 80 percent of smoked catfish processors transported their products using public transport, while 75 percent of them sold direct to consumers in a simple but efficient distribution and marketing system. Sixty-five percent of respondents rated sales as high for reasons of taste, flavour and protein value.

Hence, the following paragraphs are geared towards proposals for potential improvements and resolving hindrances to women's access to market. Although there are many different topics that need to be considered for improving the market environment and market access for women fish smokers and fishmongers, the two most crucial ones are capacity development and access to financing and savings instruments. Capacity development in particular is a cross-cutting issue that is to be embedded in all the different dimensions detailed here below.

Availability of and access to financing and savings tools

The activities of women fish processors and fishmongers, including the acquisition of the FTT technology and up-to-standard storage facilities during glut seasons, are constrained by a lack of access to financial institutions and mechanisms that would allow them to expand their business.

For example, in Indonesia, losses due to market forces occur annually for two months during the Muslim holidays of Eid al-Fitr and Eid al-Adha, during which much less fish is consumed than throughout the rest of the year. Smallholder fishmongers usually store fish in cold storage to cope with these circumstances, which cause quality deterioration and further lowers the price. This hiatus in trade causes problems for some small-scale actors who require income for basic needs. Efforts have been made to provide short-term credit in other sectors with similar problems through warehouse receipts (or storage cheque schemes), but lenders have issues with fisheries as they are considered a high risk (Wibowo *et al.*, 2017). By drawing on lessons learned from using warehouse receipts, financing mechanisms should be devised to better manage gaps between supply and demand in the fisheries sector for different contexts.

Credit availability through formal channels is inadequate and not tailored to the requirements of women fish processors and fishmongers. Even where banks or microfinance institutions are present locally, which is not frequent, this private-sector group of actors cannot meet their requirements, including collateral. On the one hand, most women do not have the skills to do bookkeeping or a cost-benefit analysis allowing them to define their financial needs for expansion, manage a bank account and/or a loan; on the other, most financial institutions have not explored alternative loan and investment instruments that would allow them to include women fish processors and fishmongers in their clientele. Most women are part of informal revolving credit schemes (tontines or kafos) or market associations that provide small amounts of capital. However, for larger amounts, they have to draw on family ties, which may not have, or make, funds available.

Moreover, in many households, as in the case of Côte d'Ivoire, men dominate access to, and control over, financial and material resources, with women having more limited access to land tenure. Access by men and women to banks and microfinance institution services to deposit their savings and benefit from working capital (access to a term deposit account) does not seem to present great differences, although more women (34 percent) are members of tontines, compared with 21 percent of men (Rosenthal, forthcoming).

Spurring changes in fish safety standards: the role of processors and consumers

Many processors still hesitate about changing their practices and actively and responsibly participating in cooperatives that can provide economies of scale with the best preservation, drying, cooking and smoking facilities. In countries where the FTT has been introduced, a number of processors have already been trained in manufacturing co-products based on local bycatch considered of low value, and this activity should be undertaken in an environment compliant with adequate hygiene standards. There is a need for the competent authorities to bring government, non-governmental-organization and project staff to provide support to market

actors, and more particularly fishmongers, to disseminate clear information and more understanding on the irrefutable positive reasons for which the FTT represents the future in fish hot-smoking and drying for both processors and consumers, thus creating a clear sense of market needs and identifying potential clients. This should then allow fish processors to devise a production strategy in an informed manner.

In Burkina Faso, demand for FTT-smoked products exceeds supply. Study findings showed that the commercial partnership is having difficulties in taking off because the women could not supply agreed quantities of FTT-Dafing smoked products. To foster ownership and adoption of this new technique by women fish processors, it is essential to develop their organizational capacity, highlighting the need for awareness building in terms of economies of scale, and organization among different users of any FTT platform that encompasses fish arrival times, household tasks schedules, etc. (L.B. Akoun, personal communication, 2018).

With favourable market forces, the bulk of fish smoked with the FTT could be sold on domestic markets. This would entail having reasonable market requirements, as the European Union (Member Organization) does, which are stringent but consistently monitored and quite rewarding and mutually advantageous for value chain actors and consumers in terms of both health standards and earnings.

Physical distribution of fish

In most African and Asian countries, roads are the main means of transportation for foodstuffs, whether fresh or processed. Thus, the availability of these products on the right market at the right time is highly dependent on road quality, and on accessibility and market inspectorate services. Every means of road transport is used in Africa to bring fish to markets including pick-up vans, lorries, private vehicles, public transport, taxis, bicycles, motorcycles, animal-drawn carts, donkeys and walking. Fishmongers may travel with the consignment or may follow the consignment using public transport or shared taxis. However, large motorized forms of road transport such as pick-up vans or lorries may not be available on a daily basis or may not coincide with market days, requiring fishmongers to spend a lot of time on travel. Smallholder women fishmongers, with less access to capital, face this problem more acutely. This is compounded with poor road conditions in many locations, resulting in vehicles breaking down, extending travel time or inaccessibility during heavy rains.

Moreover, transporters face frequent roadblocks or checkpoints in a number of countries (Bungubetshi *et al.*, 2018; Diomandé, Holvoet and Coulibaly, 2018; International Collective in Support of Fishworkers, 2002), and at border inspection points. At these checkpoints, the unfortunate reality in too many countries is that police officers and customs officials perceive their salaries to be inadequate, resulting in requests for unofficial payments (Barka, 2012; Gana and Sule, 2015). This also adds to transport time and costs, on top of which fishmongers may also face losses through breakage, as fish may be mishandled at checkpoints, or physical losses when seizures occur.

Although road conditions improved in many African countries in the last 15 years, much remains to be done. In 2010, SSA's total road network was 204 km per 1 000 km² of land area, of which about 25 percent was paved, compared with the world average of 944 km per 1 000 km² of land area (Mafusire *et al.*, 2010). These issues encompass the whole trade activity in the continent and should be embedded in the different strategies of the regional economic communities (RECs) of the African Union as well as national infrastructure plans. Regarding fish trade specifically, findings from the 2013 PHLA studies conducted in Burkina Faso, Côte d'Ivoire, Ghana, Mali and Togo all showed that the road network was in poor condition, and that the means of transport were inadequate (Diei-Ouadi *et al.*, 2015).

Women also face constraints related to mobility opportunities; first, as a result of responsibilities at the household level obligating them to rely either on paid assistance or their daughters, which can reduce these children's school attendance or time dedicated to studying. Second, women consider insecurity (including sexual harassment and rape) on roads, transaction sites and markets at very early or late hours as a priority issue that needs to be addressed. Both of these issues hinder the dynamism and know-how of women in entrepreneurship and their power to tap into opportunities offered by regional markets (Holvoet, 2016).

Limited marketing infrastructure

Retail outlets for foodstuffs are mainly open markets and supermarkets. FTT products (which have been properly smoked and present very low PAH levels) can be sold on open markets. Countless reports and photographs show that facilities in most markets in developing countries are inadequate. Although fishmongers (retailers and wholesalers) are almost always required to pay market taxes and various levies, market conditions are usually poor throughout Africa, and often even worse outside country capitals.

All too often, storage, cold chain and selling infrastructure, waste management, potable water supply and sanitation facilities are not up to standard or are non-existent, thus creating unsanitary conditions and hindering food safety and quality assurance. This is associated with a high likelihood of cross-contamination, as fishery products stalls are usually not separated from vegetable or livestock-product ones, including those for eggs (forbidden under GHP rules). Most of these facilities and services are under the responsibility of municipal authorities, although their management might be part of a private or public-private scheme. Trading activities are often disrupted by rain, given existing market facilities conditions, resulting in even more losses.

Figures 26 and 27 illustrate the lack of facilities, water, adequate selling stands and basic hygiene found in many markets.



These conditions do not foster a good marketing environment that can attract upper- and middle-class consumers who would pay premium prices.

Market information

In many contexts, fishmongers rely on informal networks or personal visits to various markets to obtain information on prices and demand in other markets. Thus, processors and fishmongers face challenges to tailor their products to meet demand, price their products, build stable commercial relationships, or find new markets

for their products. As discussed in detail in Chapter 9, according to field surveys (Akoun, 2018; Mindjimba, 2017a, 2017b), very few urban dwellers in most country case studies are aware of the existence of the FTT and its products, or where to find them. This calls for more visibility of FTT products. It is likely that consumers would be willing to buy FTT products if they were sensitized and educated about their higher quality and safety. Thus, the ways and means through which the message is communicated are crucial.

CONCLUSION AND RECOMMENDATIONS

Conclusion

A balance needs to be struck between the undisputed comparative advantages of the FTT *vis-à-vis* other fish processing methods on the one hand, and the potential contextual trade-offs that may affect the adoption of this new technology. From the foregoing, it can be seen that blind, wholesale adoption of the FTT may come with serious economic and FSN challenges. Countries seeking to adopt this innovation must do so from the launch pad of sound, context-relevant evidence. It is important to note that although demand for smoked fish is increasing rapidly, especially in Africa and Asia owing to rapid population growth, the prevailing rural marketing environments in the two regions pose a number of challenges to the adoption of the FTT. The low incomes, expenditure patterns, and literacy levels, as well as substandard infrastructure, communication and credit facilities, call for much preparatory work before this market segment can adopt the technology.

On the other hand, the growing competitiveness of the smoked-fish trade in intraregional and international markets induced through market-led quality and safety requirements provides a suitable entry point for successful and sustainable adoption of the FTT. With a first phase of export-oriented actions, a second phase adoption for domestic markets would be easier. This does not preclude the need for effective policy and regulatory framework reorientation to safeguard against potential exclusion of poor post-harvest fish practitioners from this rewarding business.

Recommendations: mitigation of market challenges

The following are recommended for addressing the identified marketing challenges:

- FAO is a member of the Improving Capacity Building in Rural Finance (CABFIN) project (RFILC, 2018), which has designed training for financial institutions to be in a position to design alternative financial instruments for agricultural enterprises, which encompass fisheries and aquaculture businesses. Support and collaboration with CABFIN could be promoted by the public sector to bring about better credit flow and business growth.
- FAO and the International Atomic Energy Agency have developed the VETLAB (veterinary laboratories) network, comprising 32 African and 17 Asian national animal-disease diagnostic laboratories sharing experiences and information, and potential collaboration on issues related to fishery products should be explored further (FAO, 2015b, 2015c). Moreover, fisheries and aquaculture are often part of the same ministry as public livestock production and health services, which should facilitate collaboration.
- General public sensitization campaigns regarding the benefits of fish dried or smoked with FTT can be designed around the following arguments:
 - studies conducted in Côte d'Ivoire and in Ghana have shown its clear health advantages;
 - its nutritional content is higher;

- as its price is the same as the price of traditionally smoked fish on local and domestic markets, given that they do not need to discard what is charred, consumers should actually purchase less;
- it is easily recognizable by its golden colour and shiny aspect.

Governments and the private sector (including processor cooperatives) should promote these campaigns hand-in-hand so that responsibilities are actually shared, with the government safeguarding consumers and encouraging them to make good choices, and the private sector priding itself on providing these high-quality products.

Depending on the national or local context, these campaigns will use the most effective media and information and communication technology supports, which may include:

- radio shows;
- news programmes on television;
- videos shown on television programmes;
- cell phone information flashes;
- posters;
- information booth at the entrance of a market;
- kakemonos;
- special events co-sponsored by the fisheries authorities and cooperatives.

Ten specific recommended support actions are:

1. Processors should benefit from further support to ensure the FTT's adoption sustainability by:
 - reinforcing their awareness on the importance of economy of scale, GHPs and how the FTT preserves their health and saves time;
 - actively involving them in the design of FTT units or platforms adapted to the local context and customs and the choice of location for each unit or platform;
 - having market tests conducted for different co-products based on local bycatch.
2. Cooperatives should receive support in identifying domestic professional clients, such as supermarkets, restaurants and hotels, boarding schools and hospitals, residing expatriates and diplomatic missions, and organizing special events with them.
3. Basic marketing techniques should be encouraged, such as helping processor groups or cooperatives build a brand, produce business cards or print product labels with marketing information and contacts, with a view to enhancing visibility and helping drive and stabilizing sales.
4. Dedicated market stalls for FTT products that may actually be labelled with their cooperative's logo/name should be set up. This calls for specific accounting and marketing skills (potentially exchanging with fair trade and/or farmers' markets in other parts of the world).
5. Participation in local, national and regional trade fairs can provide opportunities to present high-quality products while also giving processors the chance to see what others are producing and to create sales with potential customers.
6. Fishmongers of FTT products should be trained in communicating with their clients on the quality of their products (safe, higher nutritional value, better for the environment – potentially with a reforestation campaign – reduced losses and less waste, longer shelf-life, product quality meeting international safety standards while preserving local flavour, taste and aroma, and hot-smoking practices, etc.).

7. At the national level, remove illegal and trade roadblocks through a ban spearheaded by police and army commanders. Strengthen requests from the fisheries sector as a whole, from wholesalers to artisanal fisheries representatives to dialogue with government and RECs to take action on dismantling unnecessary checkpoints, including illegal ones.
8. Investments should be made to improve market hygienic conditions and infrastructure.
9. A study should be conducted on good practices regarding access to market information by producers in different agricultural, livestock and fisheries value chains to inform guidelines for fisheries interest groups, state services and chambers of commerce.
10. Fisheries ministries should have a marketing division that can provide capacity development at provincial/district level, especially for extension workers. Market information should also be made available through the different communication tools, including information and communication.

As demonstrated in Chapter 6, the benefits of the FTT are so evident that they do not require a debasement of traditional kilns and their products in order to be appreciated.

Chapter 8

Experience with regard to dissemination of the FTT across sub-Saharan Africa and Asia

INTRODUCTION

In view of its attributes and the crucial contribution of smoked and dried fish to food security, employment, income, trade and economic growth, several SSA and Asian countries have already experienced the use of the FTT in their fisheries, generally with the support of development agencies, while others are contemplating doing so. This chapter reviews the introduction of this new technology in the said countries in relation to national sector, policy, legal and regulatory frameworks governing food security and safety, and the promotion of improved fish smoking techniques in general and the FTT in particular. Key policy-support elements arising from these case studies are detailed in Chapter 9.

INTRODUCTION OF THE FTT IN SUB-SAHARAN AFRICA AND ASIA

As illustrated in Figure 28, the FTT has to date been introduced in 15 SSA countries – Angola, Burkina Faso, Burundi, Cameroon, Côte d’Ivoire, the Democratic Republic of the Congo, Equatorial Guinea, the Gambia, Ghana, Guinea, Guinea-Bissau, Nigeria, Senegal, Togo and the United Republic of Tanzania – and 1 Asian country – Sri Lanka. A historical background of the introduction of this new system in each country is briefly summarized below.

Angola

The first post-harvest technological platform (comprising two FTT prototypes Banda and Altona kilns among other facilities, as shown in Figure 29) was established at Saraiva (on the shores of Lake Ngolome) in Cuanza Norte Province in 2014 as part of FAO technical cooperation project TCP/ANG/3403 Support to Small-scale Inland Fisheries: Dissemination of Post-harvest Techniques in the North-West of Angola. The government has since embarked on a roll-out programme of post-harvest technological platforms (comprising FTT kilns) across the country with technical assistance from FAO through the Unilateral Trust Fund UTF/ANG/058/ANG Technical Assistance in Responsible Fisheries and Products Utilization in Inland Riparian Communities. Two sites have been selected to this end, namely Mulondola in Moxico Province, and Val do Loge in Uíge Province (Mindjimba, 2017b).

The Angolan fisheries and aquaculture sector is regulated by the Fisheries and Aquaculture Master Plan 2006–2010, and Fisheries Act No. 16/05 of 2005 amending Act No. 6-A/04 on Aquatic Biological Resources of 2004 (Mindjimba, 2017b). Although food security is a crucial objective of this framework, it is apparent that no specific regulatory provisions have been made regarding fish safety in general and PAHs in particular, and hence the promotion of the FTT.

Burkina Faso

In Burkina Faso, three post-harvest technological platforms have been established in Di, Niassan and Gouran (on the shores of the Sourou reservoir) with technical and financial assistance from FAO as part of the FMM/GLO/103/MUL Project Permettre aux femmes de bénéficier de façon plus égale des chaînes de valeur agro-alimentaires (Akoun, 2018; FAO, 2018e). These platforms, which are intended for three clusters of some 50 women fish smokers, comprise 12 improved kilns (improved Dafing and FTT-Dafing).

The country's existing legal and regulatory framework does not provide for the promotion of the FTT. However, the national Fisheries and Aquaculture Policy of 2014 aims to add more value to fishery and aquaculture products by improving fish quality and utilization through appropriate preservation along the value chain, among other specific objectives and policy pillars (SGG-CM, 2015).

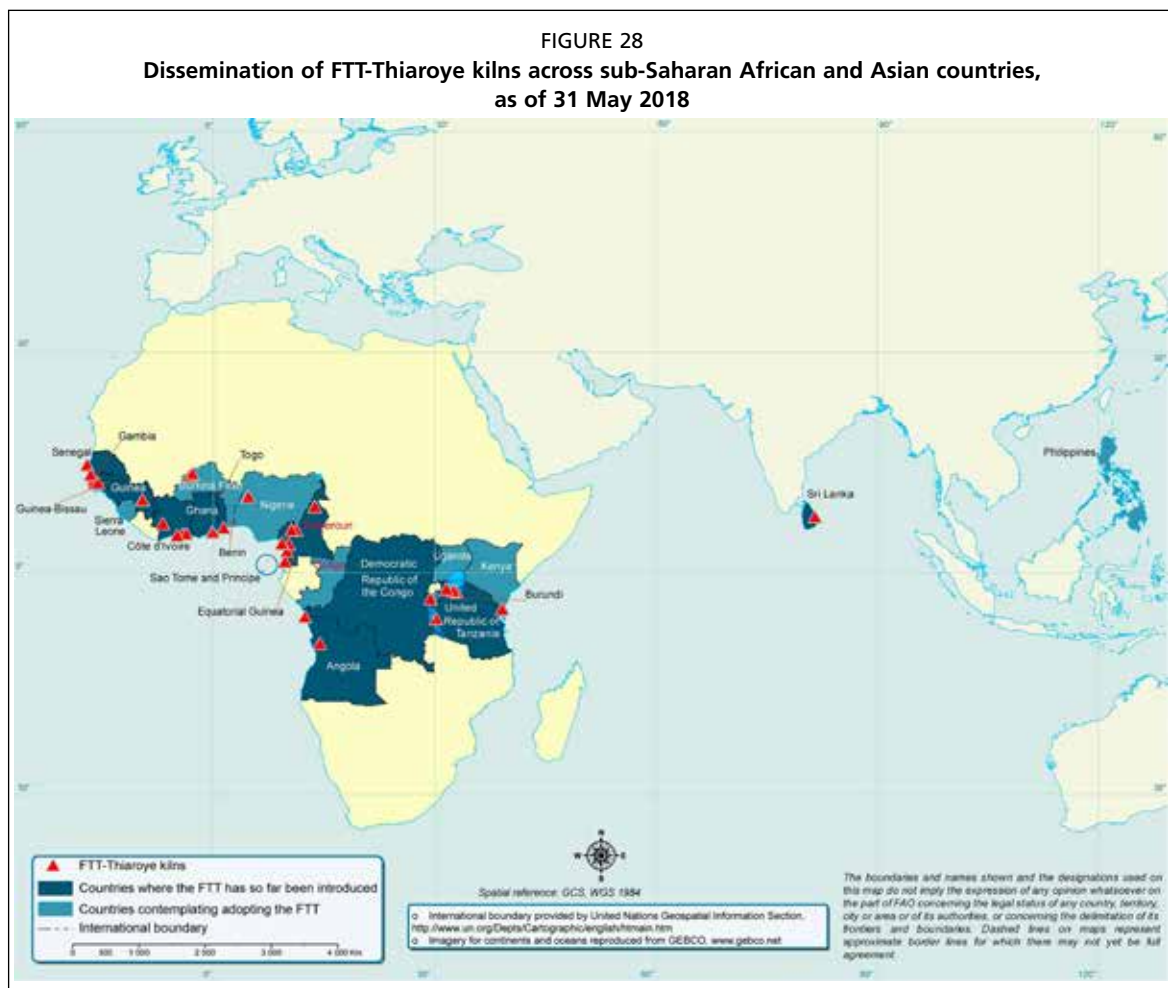

Source: G.N. Etamé and authors.

FIGURE 29
FTT Banda kiln at the Ngolome post-harvest technological platform in Angola operated by a fish processor trained under TCT/ANG/3403



© FAO/Koane Mindjimba

FIGURE 30
FTT Banda kilns in Bujumbura, Burundi, operated by a fish processor under the guidance of a technician



© FAO Country Office in Burundi

FIGURE 31
FTT Banda kilns under a shed in Londji near Kribi in Cameroon



© FAO/Koane Mindjimba

FIGURE 32
Women fish processors using FTT Banda kilns in Braffedon platform in Côte d'Ivoire



© FAO/Koane Mindjimba

FIGURE 33
Women fish processors at Timenetaye fish smoking centre in Conakry, Guinea, using newly installed FTT kilns



© FAO/Oumoulkhairy Ndiaye

FIGURE 34
Group of women fish processors in Cacheu, Guinea-Bissau, taking part in a practical demonstration of an FTT kiln newly installed in their community



© FAO/Oumoulkhairy Ndiaye

FIGURE 35
Women fish processors in Unnichchai, Batticaloa District, Sri Lanka, using a newly installed FTT kiln in their community



© FAO in Sri Lanka News

FIGURE 36
Participants using charcoal to smoke fish on FTT kilns installed in their community in the United Republic of Tanzania



© FAO/Greyson Kissai

Burundi

The FTT was launched in Burundi in 2017 under the FAO TCP project *Appui d'urgence à la reconstitution des moyens d'existence des ménages vivant de la pêche affectés par les dommages causés par les inondations et éboulements* (Figure 30). In Rumonge Province, 300 families, organized into 10 groupings, received 4 units of FTT kilns for improved fish smoking. Fishing activities are now carried out under environmentally friendly conditions, and following international food safety standards. Strengthening the production capacity through the use of improved equipment and trainings should improve not only the livelihoods of beneficiary households, but also their resilience to external shocks and particularly those related to climate change.

Cameroon

In Cameroon, six FTT units are being piloted in Londji (near Kribi), Limbe and Mouanko along the coast, and Matta Barrage, Bambalang and Djipordé (near Lagdo) in the hinterland under the auspices of the FAO Country Office. Most of these kilns were constructed under a shed (Figure 31) or a smokehouse.

The Fisheries and Aquaculture Policy Document (DSP-PAC) forms the sector policy framework. Fish processing and trading is one of the eight policy pillars of this document (SOFRECO, 2011). As in many other country case studies under review, there is no specific national regulation relating to PAHs, while the sanitary control system is weak, especially for SSF (Djessouho, 2018).

Côte d'Ivoire

The FTT was introduced in Côte d'Ivoire, first as a semi-industrial unit by the United Nations Industrial Development Organization (UNIDO) in 2010, primarily to address the PAH concern and subsequent self-imposed ban on exports. As explained in Peñarubia (2017), the decision to suspend the country's export of smoked fish to the European Union (Member Organization) from 2006 to 2011 was taken in a bid to regain this lucrative market by complying with its food safety standards.¹⁴ Four FTT platforms were later successively introduced to SSF in Abobo-Doumé (Abidjan), Braffedon, Guessabo and Marcory-Anoumabo (Abidjan) between 2013 and 2016 under FAO TCP/IVC/3501 *Appui au renforcement des capacités et du cadre réglementaire en matière de prévention et de réduction des pertes après capture des*

¹⁴ As indicated above, the country lost USD 1.6 million as a result (Peñarubia, 2017).

produits halieutiques en Côte d'Ivoire (Figure 32).¹⁵ To boost market access of FTT products, a differentiation process between these products and those from traditional methods through proper labelling, packaging and marketing (Diomandé, Holvoet and Coulibaly, 2018) has been initiated under the above-mentioned FMM/GLO/103/MUL as a follow-up action to TCP/IVC/3501.

Reference instruments, which globally aim at reducing PHFL and hence fostering fisheries and aquaculture production, include: Fisheries and Aquaculture Act No. 2016-554 of 2016 (Côte d'Ivoire, 2016); National Livestock, Fisheries and Aquaculture Strategic Development Plan (PSDEPA) 2014–2020; and Fisheries and Aquaculture Master Plan 2010–2025 (Côte d'Ivoire, undated a, b). A national programme for the dissemination of the FTT platforms across the country has been devised within this framework (Mindjimba, 2017a).

Democratic Republic of the Congo

In the Democratic Republic of the Congo, an FTT post-harvest technological platform was established in Lemvo fishing village on the estuary of the River Congo (Muanda) in 2016 as part of FAO TCP/DRC/3502 Appui à la réduction des pertes post-capture du poisson dans l'Estuaire du Fleuve Congo, province du Kongo Central (Bungubetshi *et al.*, 2018).

Fisheries and aquaculture in the country are governed by the national Fisheries and Aquaculture Policy, and the Aquaculture Strategic Action Plan 2010–2015. Ensuring food security for the population is a guiding principle of this policy framework.

Equatorial Guinea

At the Government of Equatorial Guinea's request for technical support for the development of its SSF sector in 2015, FAO developed TCP/EQG/3602, which was concluded in mid-2016. In fact, fisheries are “the second pillar of the Strategy for Social and Economic Development for Equatorial Guinea” (FAO, 2016e). Moreover, “the priority areas of cooperation between FAO and Equatorial Guinea are: increasing food production and management of natural resources; marketing, processing and rural finance; and strengthening institutional capacity” (FAO, 2018f). Following an initial evaluation of the situation and a PHFLA in Melong-Melong, Iyubu and San Antonio de Palea, the interventions in the different sites were planned. It was agreed to build processing facilities to salt and to smoke fishery products in certain districts, providing guidance for the development of cooperatives and business plans as well as training on GHPs. These pilot activities could be duplicated in other communities of the country with similar characteristics, as well as in other neighbouring countries such as Sao Tome and Principe under the current TCP/STP/3603.

It is within this framework that an FTT kiln was built in Bata and inaugurated by the competent authorities in February 2014 with the active participation of the community (FAO, 2018g). This is in line with one of the five fisheries and aquaculture policy pillars under Equatorial Guinea 2020 (2007) that has been translated into programmes, namely, the construction of a multifunctional fish processing and trading platform. This will be achieved through value addition to fish and fishery products, capacity development and competitiveness of fishers and fish farmers, adoption of improved fish processing methods, compliance with fish quality and safety standards as well as exploration of new market outlets, among others (SOFRECO, undated).

Gambia

In the Gambia, the FTT was launched in Brufut in 2013 through the UNIDO-funded Integrated Support to the Fisheries Value Chain in the Gambia (SAP ID: 101119). This

¹⁵ The latter is dubbed “FTT-Abidjan” owing to its specificities (Mindjimba, 2017a).

new technology was then brought to the benefit of small-scale fish workers through a FAO regular programme initiative in 2018, in the community of Gunjur (Cham, 2018). The Government of the Gambia adopted a new Fisheries Policy in 2007 with the objectives of ensuring rational and long-term utilization of fisheries and aquaculture resources and improving the nutritional standards of its population, among others. Fisheries management is regulated by the Fisheries Act (2007) and its attendant Fisheries Regulations (2008). These two regulatory instruments lay more emphasis on fisheries management, monitoring, control and surveillance (MCS) and are virtually silent about fish safety and sanitary control.

Ghana

In Ghana, the FTT was introduced in Accra in 2014 by the FAO and SNV Ghana Improved Fish Smoking and Mangrove Restoration Project (Okyere-Nyako, Aziebor and Robinson, undated; Joy Online, 2014). The United States Agency for International Development Agency (USAID) is also supporting this new technique under the Sustainable Fisheries Management Project (SFMP) through establishment of an FTT kiln for a privately owned, small-scale fish and agricultural processing centre in Elmina to process fish for local and export markets (Antwi and Beran, 2018). The Department of Nutrition and Food Science of the University of Ghana included the FTT in its curriculum on animal products processing technology in 2017 in a bid to promote this technology and instigate further research in improved fish smoking systems.

The FAO Regional Office for Africa is currently developing a project to build FTT units for smallholder fish processors in Ghana. As part of this drive, one unit is to be built at the University of Ghana for teaching and research purposes. Meanwhile, a multidisciplinary stakeholder committee has been formed to develop a simplified grading scheme for smoked fish (Atikpo *et al.*, 2018).¹⁶ Under this scheme – which seeks to establish “the standards and levels of PAHs and micro-organisms in the smoked fish that would be tolerable for human consumption” – a fish processor processing fish under good hygienic and good manufacturing practices (GHPs and GMPs) will be issued a premium Class One certificate of recognition, whereas Class Two is achieved when Hazard Analysis and Critical Control Points (HACCP) have been implemented in the processor’s facilities. Smoked fish with the Ahotor oven will be awarded a Class One certificate, while the FTT is required for Class Two with regard to stringent safety measures. Class Two will allow fish processors to export their produce to other African countries, while processors reaching the highest status, i.e. Class Three, will be allowed to access international markets like the European market. Each class status will be labelled on packed fish “to boost consumer confidence and patronage”.

More generally, PAHs in smoked fish and fishery products in Ghana are regulated by the Republic of Ghana Fisheries and Aquaculture Policy (2008) (Abban *et al.*, 2009).

Guinea

The Government of Guinea adopted a Fisheries and Aquaculture Policy Document in 2015 (Ministère des Pêches, de l’Aquaculture et de l’Économie Maritime, 2015). This document recognizes the need to meet the international standards for export of fish and fishery products, especially the European market with regard to safety standards and procedures as well as traceability and the fight against IUU fishing. It also takes into consideration the African Union Commission / NEPAD Policy Framework and Reform Strategy for Fisheries and Aquaculture in Africa (2014) with the aim of improving food security and enhancing the value of fish by improving fish safety

¹⁶ This committee consists of representatives from Ghana Standards Authority, Fisheries Commission, Food Research Institute of the CSIR, Food and Drugs Authority, National Fish Processors and Traders Association, FAO Ghana, University of Cape Coast, University of Ghana, SNV and other local partners of the SFMP (Samey and Tibu, cited in Atikpo *et al.*, 2018).

standards along the value chain, among others. It is within this framework that the country introduced the FTT in 2017 under the UNIDO-funded project PA 140046 Update SPS Standards and Value Chain to Improve Artisanal Fishers' in West Africa (Côte d'Ivoire, Guinea, Mauritania and Senegal) Access to Regional and International Markets. Figure 33 shows women fish processors in Guinea using the newly installed FTT kilns at the Timenetaye fish smoking centre in Conakry. The government earlier developed the Fisheries and Aquaculture Development Policy Paper in 2009, of which adding value to fishery and aquaculture products is one of the strategic pillars (Ministère de la Pêches et de l'Aquaculture, 2009).

Guinea-Bissau

In Guinea-Bissau, three FTT platforms (with FTT Banda kiln prototypes as shown in Figure 34) were constructed in Bidjilim, Cacheu and São Vicente in 2014 under the FAO TCP/GBS/3401 Support to the Enhancement and Sustainable Management of Artisanal Fisheries Productions (FAO, 2016f; Ndiaye, 2015).

Nigeria

Two prototypes (a detachable typical FTT and a solar FTT modified from the original design) were designed in Nigeria by the Nigerian Fisheries and Freshwater Research Institute and the Nigerian Institute of Oceanography and Marine Research (NIOMR). This was achieved in line with the West Africa Agricultural Productivity Programme (WAAPP-Nigeria) mandate to reduce or eliminate PAHs in smoked fish. The new prototype is said to be collapsible and easy to transport. The design of these two fish-processing kilns notwithstanding, it is apparent that there is no national regulation on PAHs (Djessouho, 2018).

Senegal

Senegal, it should be recalled, is the country where the FTT was designed in Thiaroye (Dakar) in 2008–09 through an FAO/CNFTPA Letter of Agreement. The first FTT in CNFTPA was an incubation or experimental equipment for pilot testing and subsequent adjustments, as appropriate. It was then installed in a fishing community for actual operation by users in the coastal fishing village of Mballing in 2012–13 as part of FAO activities establishing FTT kilns in the country – fish processing and sanitary security. The didactic videos on the FTT were developed during this period.¹⁷ Another FTT unit has subsequently been established at the Kayar fishing site in 2016 under CONFISH-USAID.

Although the competent authorities for sanitary inspection – the National Aquaculture Authority and the Direction des Industries de Transformation de la Pêche – recognize the effects of PAHs and the possibility to carry out B(a)P tests abroad (in Morocco or in Mauritania), to date, there is no national regulation on this contaminant (Djessouho, 2018). Fisheries and aquaculture have been identified among the strategic economic development sectors under the Emerging Senegal Plan of 2013 (Senegal, 2014). This will be pursued by increasing the value of fisheries and aquaculture resources through construction of integrated processing units (both industrial and artisanal), among other policy actions. The new Fisheries and Aquaculture Sector Development Policy Paper of 2016 also promotes food and nutrition security while adding value to fishery and aquatic products, among other objectives (Leral Net, 2016). It forms the baseline and reference framework for investment in the sector for the period 2016–2023 (FAO, 2016g).

¹⁷ The three didactic videos on the FTT produced by FAO are available at: (i) www.youtube.com/watch?v=4ehj-lNscb8; (ii) www.youtube.com/watch?v=nmLak9hDLXM; and (iii) www.youtube.com/watch?v=nk7eaZWTifs (accessed 14 September 2018).

Sri Lanka

Sri Lanka is the first country where the FTT has been introduced beyond its region of origin, Africa. In fact, as in many other developing countries, fish are known to be a major source of livelihoods, food security and nutrition in Sri Lanka. The first FTT unit in the country was established in Unnichchai, Batticaloa District – where some 150 families are engaged in fish-smoking activities – in 2017 through the Support to District Development Programme (SDDP) (Rotawewa and Wickramasinghe, 2018) funded by the European Union (Member Organization) in partnership with FAO (Figure 35) (FAO, 2018h). In 2018, the SDDP constructed 15 more FTT kilns in other parts of the country (Daily FT, 2017).

Meanwhile, the competent authority has initiated the review of the national regulatory framework to address PAHs in smoked fish in conformity with the Codex Alimentarius Code of Practice (CAC/RCP 68-2009 [CAC, 2009]) (Djessouho, 2018). This review is aligned with two objectives of the sector policy objectives, which are to: (i) improve the nutritional status and food security of the people by increasing the national fisheries production; and (ii) minimize PHL (estimated at about 30 percent) and improve fishery products safety and quality to acceptable standards (Ministry of Fisheries and Aquatic Resources, 2007). It is also aligned with the National Policy and Strategy on Cleaner Production for Fisheries Sector (2008). In fact, the latter policy provides for the introduction of cleaner production technologies in the sector with a view to ensuring “high standard of quality and safety of fish and aquatic products” in the country (Ministry of Fisheries and Aquatic Resources, 2008).

Togo

Togo is the first country where the FTT was rolled out in 2010 from its experimental site (CNFTPA facilities). This was achieved within the framework of the Strengthening Fishery Products Health Conditions in ACP/OCT Countries (SFP) Programme funded by the European Union (Member Organization). The World Bank also supported the new system through the Togo Agriculture Sector Support Project (PASA) in 2015.

United Republic of Tanzania

In 2013–2014, the SmartFish Programme supported the establishment of 15 FTT kilns in the United Republic of Tanzania in areas where the Fisheries Education and Training Agency (FETA) has outreach centres (Figure 36) on the shores of Lakes Victoria (Nyegezi and Muleba) and Tanganyika, Sengerema (Mwanza Region) as well as along the coast (Mbegani around Bagamoyo).

Fisheries and aquaculture in the United Republic of Tanzania are governed by the National Fisheries Policy (Ministry of Livestock and Fisheries Development, 2015) and the Zanzibar Fisheries Policy (Zanzibar, 2014) for Tanzania Mainland and Zanzibar, respectively. These policies aim *inter alia* to “increase fish supply and improve quality of fish and fishery products in line with food security requirements of the population and compliant to international standards.”

The competent authority is revising the national regulation on PAHs for implementation by the Tanzania Bureau of Standards. Meanwhile, the Codex Alimentarius Code of Practice (CAC/RCP 68-2009 [CAC, 2009]) is being used as the reference text for sanitary control, for which the National Fish Quality Control Laboratory is the competent authority (Djessouho, 2018).

Table 17 summarizes the inventory of FTT kilns in the country case studies under review.

TABLE 17

Inventory of FTT kilns in sub-Saharan African and Asian countries, as of 31 May 2018

No.	Countries	Location	Year launched	Related programme / project
Sub-Saharan Africa				
1	Angola	Saraiva (Lake Ngolome)	2014	FAO TCP/ANG/3403
2	Burkina Faso	Di, Niassan, Gouran (Sourou reservoir)	2017	FAO FMM/GLO/103/MUL
3	Burundi	Bujumbura	2017	FAO TCP/BDI/3602
4	Cameroon	Londji (Kribi), Limbe, Mouanko, Matta Barrage, Bambalang, Djipordé (Lagdo)	2016	FAO Cameroon
5	Côte d'Ivoire	Semi-industrial fishery Abobo-Doumé (Abidjan), Marcory-Anoumabo (Abidjan), Guessabo, Braffedon	2010 2013–2016	UNIDO FAO regular programme FAO TCP/IVC/3501
6	Democratic Republic of the Congo	Lemvo (Muanda)	2016	FAO TCP/DRC/3502
7	Equatorial Guinea	Bata	2014	FAO TCP/EQG/3602
8	Gambia	Brufut Gunjur	2013 2018	UNIDO-funded project FAO regular programme initiative
9	Ghana	Accra	2014	FAO/SNV Ghana USAID-SFMP
10	Guinea	Timenetaye fish smoking centre (Conakry)	2017	UNIDO PA 140046
11	Guinea-Bissau	Bidjilim, Cacheu, São Vicente	2014	FAO TCP/GBS/3401
12	Nigeria	New Bussa		WAAPP-Nigeria/NSPRI
13	Senegal	Thiaroye (Dakar) Mballing Kayar	2008–2009 2012–2013 2016	FAO/CNFTP Protocol Agreement FIU-FAO Rome CONFISH USAID
14	Togo	Lomé	2010–2014 2015	SFP-ACP.EU Programme World Bank Togo PASA
15	United Republic of Tanzania	Mbegani (Bagamoyo), Nyegezi, Muleba (Lake Victoria), Sengerema (Mwanza Region), Lake Tanganyika	2013	SmartFish Programme
Asia				
16	Sri Lanka	Unnichchai (Batticaloa District)	2017	FAO implemented EU-SDDP

Sources: Akoun (2018); Bungubetshi *et al.* (2018); Antwi and Beran (2018); Diomandé, Holvoet and Coulibaly (2018); FAO (2018e); Mindjimba (2017b); Mindjimba and Tiotso (2018); Rotawewa and Wickramasinghe (2018).

COUNTRIES CONTEMPLATING INTRODUCING THE FTT

These comprise six SSA countries (Benin, the Republic of the Congo, Kenya, Sao Tome and Principe, Sierra Leone and Uganda) and one Asian country (the Philippines). The situation in Benin is unusual in that the FTT kilns trialled in Agniguinnou village in Mono Municipality in 2016 failed because of inadequate design and construction. However, the NGO Centre d'Initiatives pour le Développement Durable has since made efforts to improve the design and construction of these kilns, and to disseminate them in other fisheries communities of the country based on the results of feasibility studies. Securing the necessary funds is the challenge (C. Djessouho, personal communication, 2018).

CONCLUSION

To date, 16 countries (15 in SSA and 1 in Asia) have trialled the FTT, while 7 others (6 in SSA and 1 in Asia) are contemplating doing so. In addition to FTT kilns, most post-harvest technological platforms put in place have been equipped with cold chain facilities (cool boxes, deep freezers), and weighing and packaging machines. FAO has pioneered this new system either alone in most countries – Angola, Burkina Faso, Cameroon, Côte d'Ivoire, the Democratic Republic of the Congo, Equatorial Guinea, Guinea-Bissau, Senegal and the United Republic of Tanzania (within the framework of the SmartFish Programme) – or in partnership with other development agencies. The other development agencies supporting the FTT comprise the European Union

(Member Organization) (in Togo and Sri Lanka), SNV (in Ghana in partnership with FAO, and in Burkina Faso), the USAID (in Ghana), UNIDO (in the Gambia and Guinea-Bissau in partnership with FAO) and the World Bank (in Togo).

While most of these countries have incorporated food security among the strategic pillars of their national fisheries and aquaculture policies, with one exception (Ghana), they are yet to mainstream fish food safety and sanitary control in general and PAHs in particular in their policy, legal and regulatory frameworks. Those that are revising their regulatory frameworks accordingly comprise Côte d'Ivoire, Sri Lanka and the United Republic of Tanzania. Moreover, countries such as Burkina Faso, Côte d'Ivoire and Ghana have taken regulatory measures to improve the packaging and labelling system of FTT products in a bid to enhance consumer confidence and patronage.

Other tropical countries where the fisheries and aquaculture sector is a mainstay of local communities' livelihoods as well as a significant contributor to local and national economies and where fish hot-smoking and sun-drying are traditionally practised (e.g. Chad, Mali, South Sudan, India, Indonesia, Thailand and Viet Nam) may not have trialled the FTT owing to a lack of awareness and knowledge. The present document aims to fill this information gap by explaining not only the multiple benefits and advantages that this new technology offers compared with other fish processing methods, but also its trade-offs and challenges. These countries could also learn from the experiences of countries where the FTT has already been introduced.

Chapter 9

Key policy-support elements arising from the FTT case studies

INTRODUCTION

As reviewed in Chapter 8, the FTT has to date been disseminated in 16 SSA and Asian countries and is about to be introduced in 7 others. The present chapter first analyses the adoption process of this new technology. It then examines the preconditions for success and lessons learned in this context in order to promote the recurrence of desirable outcomes and preclude the repetition of shortfalls. Specific lessons learned and recommendations linked to gender equity issues are also integrated in this chapter, as women are the main users of the FTT. They could serve as a starting point when assessing the local context and women's specific priorities, prior to implementing the FTT. Finally, the chapter investigates the key policy-support elements arising from the country case studies under review. The aim is to provide some guidance for establishing such equipment in other countries.

FTT ADOPTION PROCESS

Chapter 3 has traced the FTT development process from the design of this new technology in Senegal to its introduction in a number of SSA and Asian countries. The related conceptual framework fits the traditional five-step individual innovation adoption process (Rogers, 2003), namely: (i) knowledge (awareness); (ii) persuasion (interest); (iii) decision (evaluation); (iv) implementation (trial); and (v) confirmation (adoption).¹⁸ This section focuses on the final step by analysing the determinants or influencing factors for the adoption of the FTT as opposed to those that might lead to its abandonment after a few trials. It draws extensively on the results of a recent survey conducted in Cameroon, Côte d'Ivoire and the United Republic of Tanzania (Mindjimba and Tiotsop, 2018) and a gender analysis stemming from three West African countries, namely: Burkina Faso, Côte d'Ivoire and Ghana (Rosenthal, forthcoming).

Survey results

Of the 74 FTT and traditional women fish processors and fishmongers randomly selected in the survey countries, 51 (comprising 24 out of 25 in Cameroon, 23 out of 45 in Côte d'Ivoire and all 4 respondents in the United Republic of Tanzania, or 68.9 percent) expressed their perceptions of the FTT with regard to the factors

¹⁸ The relevant literature provides several theoretical frameworks on the adoption process, which actually do not contradict one another (Botha and Atkins, 2005) but are complementary. An illustration is found in Kamal (2006) with seven stages: (i) start; (ii) innovation knowledge; (iii) innovation attitude; (iv) innovation implementation; (v) innovation confirmation; (vi) innovation decision; and (vii) organizational innovation adoption.

influencing its adoption.¹⁹ Forty-five of them (18 in Cameroon, 23 in Côte d'Ivoire and 4 in the United Republic of Tanzania) had used this new technique at least once. The analysis that follows considers only these 51 respondents and excludes the remaining 23 others (i.e. those who had never used the FTT at the time of the survey). Survey findings are depicted in Table 18²⁰ and Figure 37.

TABLE 18

Distribution of scores and ranking of factors determining FTT adoption in Cameroon, Côte d'Ivoire and the United Republic of Tanzania

No.	Factors ¹	All three countries ²		Cameroon		Côte d'Ivoire		United Republic of Tanzania	
		Score	Rank	Score	Rank	Score	Rank	Score	Rank
1	FTT kilns proximity	6.35	1	7.17	1	6.48	2	0.75	16
2	Number of FTT kilns	5.82	2	3.79	6	8.57	1	2.25	10
3	Non-pollution of the environment	5.33	3	5.00	3	6.00	3	3.50	4
4	Health safety and improved working conditions	4.88	4	6.96	2	2.43	10	6.50	1
5	Possibility to carry out other activities	4.04	5	3.21	7	4.70	4	5.25	2
6	Ease of use and reduced drudgery	3.82	6	4.17	4	3.52	8	3.50	4
7	Possibility to use alternative fuels	3.67	7	2.75	9	4.70	4	3.25	6
8	Kiln holding capacity	3.06	8	2.25	12	4.09	7	2.00	12
9	Processing time	2.67	9	3.96	5	1.22	12	3.25	6
10	Diversification and valorization of fishery products	2.63	10	2.25	12	3.17	9	1.75	14
11	Security	2.25	12	3.08	8	1.30	11	2.75	8
12	Collective use of kilns	1.76	13	2.54	10	0.87	13	2.25	11
13	Better-quality and safety of end products	2.57	11	0.71	16	4.13	6	4.75	3
14	Possibility to use the kilns regardless of weather conditions	1.25	15	2.21	14	0	20	2.75	8

¹ An increase in income or better return from premium price of end products (i.e. access to more lucrative markets) is not included among the determining factors. It is assumed this is the ultimate goal for which processors smoke their fish with the FTT and sell them at a better price.

² n = 51.

Source: Mindjimba and Tiotsop (2018).

¹⁹ The study details the methodology employed in that context, i.e. a structured questionnaire centred on a show card of up to 20 possible factors – assuming that an increase in income is the ultimate goal for which fish processors adopt the FTT – from among which the respondents were asked to rank only 10. A ten-point linear rating scale was used accordingly to rank these factors from 1 to 10, with a value of 1 for the least influencing factor and 10 the most influencing one. The survey, which took place between August and September 2017, was administered to 25 respondents from 6 fishing sites in Cameroon, 45 respondents from 2 fishing sites in Côte d'Ivoire, and 4 respondents from 4 fishing sites in the United Republic of Tanzania.

²⁰ In their study, Mindjimba and Tiotsop (2018) also analysed the effects of respondents' age, length of involvement in fish processing, educational level, and country of residence on FTT adoption.

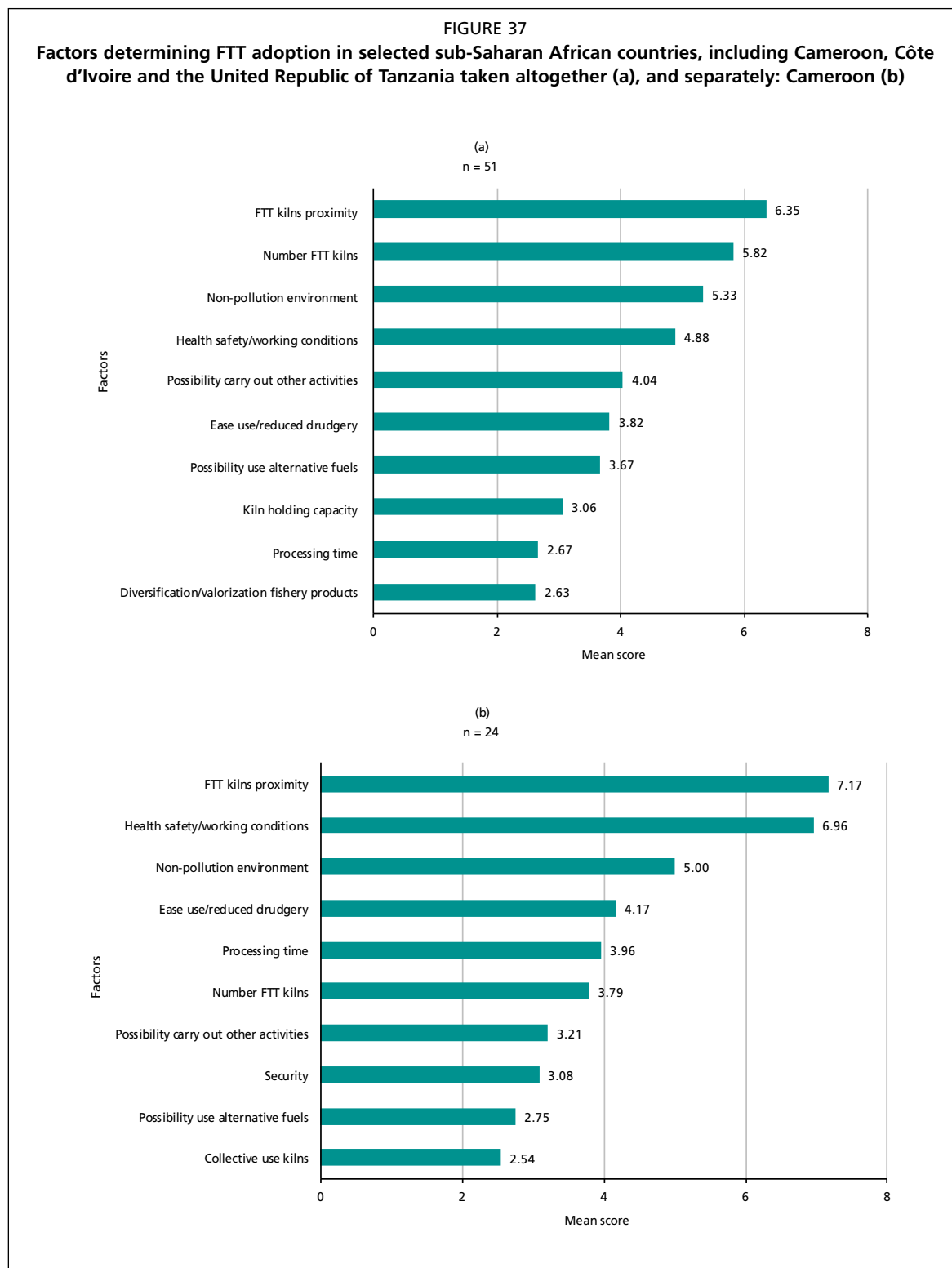

Source: Mindjimba and Tiotsop (2018).

FIGURE 37 (continued)
 Factors determining FTT adoption in selected sub-Saharan African countries,
 including Côte d'Ivoire (c) and the United Republic of Tanzania (d)

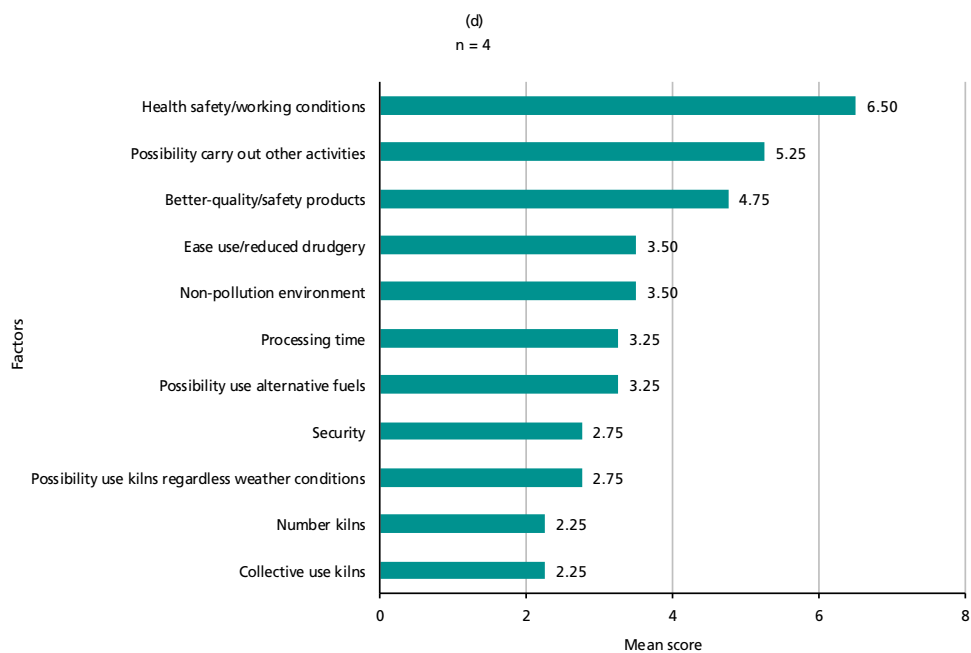
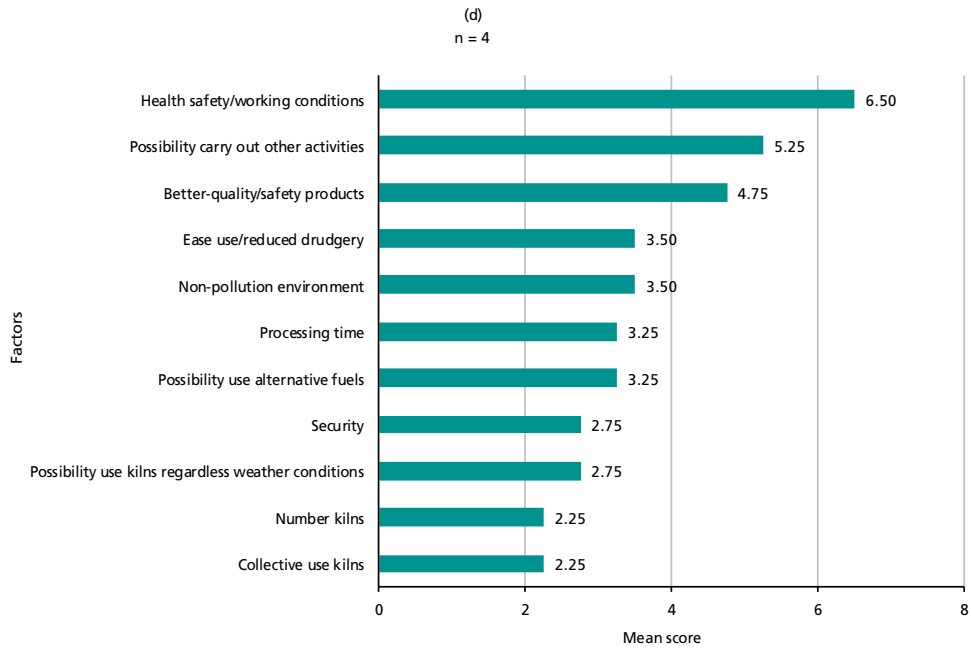

Source: Mindjimba and Tiotsop (2018).

Overall, these findings show that, in terms of score, the most significant determinants in this context are:

- the location of FTT kilns or their proximity *vis-à-vis* respondents' home (mean score of 6.35 on a maximum scale of 10) – the closer the FTT kilns are to the processors' home, the higher the likelihood that they will adopt them;²¹
- the number of kilns available (mean score of 5.82) – as in point (1), the greater this number, the higher the probability that the target processors will adopt these kilns, intimately linked to the time factor in terms of rotation within community use of the FTT;
- non-pollution of the environment (mean score of 5.33);
- health safety and improved working conditions (mean score of 4.88).

Other determinants of adoption mainly relate to the opportunities that the FTT offers processors to concomitantly carry out other activities (mean score of 4.04), ease of use and reduced drudgery (3.82), possibility to use alternative fuels (3.67), holding capacity of kilns (3.06), processing time (2.67), and diversification and valorization of fishery products (2.63).

With a mean score of 2.57, the quality of FTT products, especially their lower levels of contaminants such as PAHs (and their health impact on both processors and consumers), was not perceived as a decisive factor. As discussed below, this could be attributed to the non-price differentiation between FTT and traditional products on the local and domestic markets as well as consumer behaviour. In fact, the prevailing situation on most of these markets is that the prices of the two product types do not differ from each other. The aim of any value chain actor is to handle and process fish for a better return. If this first priority is not adequately addressed, then any FTT strengthening programme must pay particular attention to at least the first three determining factors identified above. Aspects such as valuing easier and decent working conditions, and awareness of better health conditions resulting from better processing techniques and safer fishery products, are also significant in that regard.

Sustainable use of the FTT

Field investigations further revealed that not all FTT kilns installed in fisheries communities were effectively being used by the target groups. Moreover, despite the undisputed comparative advantages of the FTT, some fish processors that had adopted this new technology were reverting to their traditional systems. The following section on the lessons learned discusses the main reasons for the non-use or abandonment of the FTT in these cases. It also offers recommendations for enhancing the likelihood of its adoption and sustainable use.

Discussion

Although the FTT fulfils all four dimensions of sustainability (economic, environmental, sociocultural and institutional), it has been pointed out that the main problems with this new technology lie less with its comparative advantages over traditional processes than with the prevailing business environment in general and non-price differentiation in particular. Consumer behaviour towards, and awareness of, FTT products and those resulting from traditional methods on the local and domestic markets is another influencing factor in this regard. As discussed in Chapter 7, this has been observed in Côte d'Ivoire (Mindjimba, 2017a), the Democratic Republic of the Congo (Bungubetshi *et al.*, 2018), and the United Republic of Tanzania (Kissai and Mgawe,

²¹ Some members of the Viwo cooperative based in Grand-Lahou in Côte d'Ivoire who had been using the FTT established in Braffedon (about 20 km away) subsequently abandoned it because of the distance and inherent costs. In general, "smoking processors prefer their traditional system that allows them to carry out this activity in the immediate vicinity of their dwellings" despite the problems associated with it (Diei-Ouadi *et al.*, 2015).

2017; Peñarubia, 2017), and could slow FTT adoption. In fact, for some fish processors, the reward in terms of fish prices and hence income does not make it worthwhile for them to shift from their traditional methods to the new system. Consumers with more purchasing power, and hence more likely to pay premium prices for a healthy product, are not even aware of the FTT's benefits. There is no consistent mechanism to convince them why they should buy these products and where to find them easily. This also contributes to the overall low price and competitiveness of FTT products on local and domestic markets. This has been observed in Burkina Faso (Akoun, 2018) where only 2 percent of the 507 people interviewed in Ouagadougou (especially among consumers and restaurant owners) were aware of the existence of the FTT (as against 98 percent who were not).

The ranking of the above factors differs somewhat from the five most appreciated attributes of the FTT identified from a survey (Randrianantoandro and Diei-Ouadi, 2015) conducted among 154 women fish processors in Benin, Côte d'Ivoire, Ghana, Kenya, Togo, Uganda and the United Republic of Tanzania (90 percent of whom appreciated its comparative advantages and recommended its use). These attributes were: (i) better-quality end products; (ii) energy efficiency (less fuelwood consumption); (iii) shorter smoking and drying times; (iv) access to more lucrative markets; and (v) larger holding capacity. Arguably, the difference in the results obtained from the two surveys stems from the methodological approach employed. In the 2015–16 survey, the respondents were asked to rank the five most commonly known benefits of the FTT, whereas in the 2017 survey, women fish processors (especially in Côte d'Ivoire) were already experiencing the deadlock over non-price differentiation between FTT and traditional products. This has probably influenced to a great extent their ranking of the most important factors for adoption of the FTT.

In sum, study findings in Cameroon, Côte d'Ivoire and the United Republic of Tanzania in particular suggest that the main factors determining FTT adoption are geographical in nature (kiln proximity *vis-à-vis* processors' dwellings), sociodemographic (number of kilns available in relation to the needs), and environmental and sanitary (preservation of processors' health and working conditions). However, some fish processors that had shifted to this new system are now reverting to their traditional processes. The reasons mainly stem from inappropriate planning, design, installation and the business environment. To sustain FTT adoption, the competent authorities must create an enabling business environment in terms, notably, of price differentiation and consumer behaviour towards, and awareness of, FTT and traditional products with regard to quality and safety. Some of the challenges with price differentiation include the likelihood of fraud, certification and confirmation of compliant facilities, packaging and labelling, and implications for monitoring and market surveillance.

PRECONDITIONS FOR SUCCESS

Precondition 1: The superiority of the FTT over traditional systems for smoking fish is a necessary but not sufficient condition for the adoption of this new technology in order to reap the anticipated benefits. Other conditions must be taken into consideration, including the prevailing business environment and consumer behaviour and awareness concerning FTT and traditional FTT and traditional products.

Overview

While the FTT is hailed as an effective and efficient solution for the problems posed by traditional fish processing systems and is appreciated by an overwhelming majority of fish processors (mainly but not exclusively women) for its attributes, it is important to take other conditions into consideration. These include the prevailing business environment in general and fish prices in particular (Lesson 9 –see below) as well as fish processors and traders' access to efficient markets and consumer behaviour and awareness concerning FTT products and those resulting from traditional methods (Mindjimba and Tiotsop, 2018). As described in this document, the fact that some consumers (in Burkina Faso, Côte d'Ivoire, the Democratic Republic of the Congo and the United Republic of Tanzania in particular) are hesitant about FTT products because of their “paleness” could slow FTT adoption.

Thus, to promote widespread dissemination of the FTT, more efforts should be geared towards creating a conducive and enabling business environment, notably in terms of price differentiation and quality labelling between FTT and traditional products on the local and domestic markets. Sensitizing and educating the population about the comparative advantages of FTT products with respect especially to their higher quality and safety are also essential, as detailed in Chapter 6. As discussed below, they constitute some of the lessons learned in this regard.

Background

As noted above, the FTT's comparative advantages, its products and technical superiority over the traditional systems for smoking fish from the food security, public health and environmental viewpoints are well documented. The reasons why the new system should be promoted are also well explained. Most studies have concluded that, if well designed and managed, the FTT can achieve its stated objectives of solving the longstanding problems posed by hot-smoking that prevail in traditional fish production systems, thus addressing FSN issues, fish processors' health and environmental concerns (Anoh *et al.*, 2018; Mindjimba and Tiotsop, 2018).

Recommendations

- Devise policy actions and market incentives in support of enhanced consumer acceptance of FTT products, given their attributes, by enabling and encouraging consumers to make more nutritious choices (Global Panel, 2017).
- Revise the fisheries regulatory framework governing PAHs with a view to ensuring the traceability of fishery products and quality control.²²
- Provide support to market information systems, the role of IT/e-marketing, etc.

²² Other countries could emulate the Ghanaian and Ivorian experiences in that regard. More efforts are needed to make sure products that are placed on the market have PAH and MTE levels that do not exceed national and international limits, and that these limits are complied with and upheld throughout the fish food value chain (Mindjimba, 2017a).

- Connect smallholders and producer organizations (POs)²³ or clusters of innovation or outstanding community leaders to agribusiness through productive partnerships in order to collectively safeguard their interests and mainstream this in national fisheries and aquaculture policies.
- Spur a culture of excellence with a framework for nationwide competition, rewarding best practices.
- Target export markets as workable entry points / early action.
- Target species that are in high demand as smoked fish such as catfish.

Precondition 2: The FTT is most likely to be successfully introduced in a country and to achieve its stated goals when food security and nutrition are embedded in national fisheries and aquaculture policies and enforcement is effective.

Overview

Existing national fisheries and aquaculture policies should be vetted for FSN to gauge the importance attached to this issue. In the absence of such policies, pioneering any improved fish processing system (including the FTT) may be challenging.

Background

The countries studied for this document have each adopted a national fisheries and aquaculture policy. As outlined in the following section, some of these policies are aligned with international and regional policy instruments such as the Malabo Declaration, the PFRS for Fisheries and Aquaculture in Africa, the Volta Basin Strategy in West Africa, the East Africa Standard for Smoked Fish, and the Resolution on Sustainable Fisheries for Food Security for the ASEAN Region Towards 2020.

In general, these policies recognize the current and potential significance of the sector. Some of them further underline the issue of the sector's sustainable management and its resources as well as food security, especially in the face of declining fish stocks, magnitude and occurrence of high post-harvest fish losses and waste, thereby providing an appropriate framework for dissemination of the FTT. However, regarding food safety issues linked to FTT in these countries, the study findings revealed: (i) there is weak enforcement (policy on paper, implementation is a challenge) and a dearth of efforts on domestic products; and (ii) policy is usually translated into an actual strategic plan and also by enforcement when export products are concerned, ostensibly because of higher economic gains from such markets.

Recommendations

- Revise the national fisheries and aquaculture policies by incorporating FSN among the policy pillars where this is not the case.
- Enhance the enforcement mechanisms in place to ensure that the existing fisheries policy, legal and regulatory frameworks are effectively complied with.

Annex 1 summarizes the above preconditions for success.

LESSONS LEARNED

As any other technological innovation, the FTT holds important lessons that could be valuable for later project phases, similar future FTT projects and their widespread dissemination in other countries and regions, and other complementary technologies for packaging, storage, and cold chain devices. As explained in more detail below, several lessons – in terms of success and failure – can be learned, and opportunities for improvement can be discovered from the operation of the FTT in the country case

²³ A few such POs and associations already exist in countries such as Côte d'Ivoire, the Democratic Republic of the Congo and Ghana.

studies (particularly Angola, Burkina Faso, Cameroon, Côte d'Ivoire, the Democratic Republic of the Congo, Ghana, Sri Lanka and the United Republic of Tanzania). These lessons aim to provide some guidance for establishing such infrastructure in other countries (Mindjimba, 2017b; Mindjimba and Tiotsop, 2018), especially in the case of a community-based infrastructure. Indeed, experience with development assistance shows that, in general, interventions in SSF are more effective and sustainable when groups of operators rather than individuals are targeted. The benefits of the FTT as outlined in the preceding chapters are good reasons why this document focuses on producer groups and organizations. This focus notwithstanding, individual fisheries operators are not sidelined given that some agencies such as UNIDO usually support individual operators and the private sector. The aim of the document in general and this section in particular is to raise the interest of UNIDO and other donors in investing in the FTT.

The lessons learned are grouped under three project cycle headings: (i) planning and design (including the situation analysis regarding the enabling environment as this is a precondition to FTT success); (ii) implementation and monitoring; and (iii) evaluation. Each lesson learned has been structured in three parts: overview (purpose of the lesson); background to the project (as detailed in Chapter 8); and recommendations. Tables 19 and 20 provide a checklist for policymakers and programme designers and managers of FTT infrastructure, respectively.

TABLE 19

Checklist for policymakers for the establishment of FTT infrastructure

Checklist
Enabling business environment
<ul style="list-style-type: none"> • Policy actions and market incentives in support of enhanced consumer acceptance of FTT products • Actions taken to encourage consumers to make more nutritious choices • Support to a market information system including information and communication technology, e-marketing, etc. • Establishment of a framework for nationwide competition, reward best practices with a view to spurring a culture of excellence
National fisheries and aquaculture policy pillars
<ul style="list-style-type: none"> • Food security and nutrition embedded in all policy and regulation documents • Fisheries governance • Sustainable and responsible fisheries management by-laws • Sustainable and eco-friendly aquaculture development (both small-scale and commercial) regulations • Post-harvest (including loss reduction, fish utilization, processing and trade) issues included in fisheries policies and regulations • Financing and credit issues included in fisheries policies and regulations • Capacity development issues included in fisheries policies and regulations • IUU regulations and MCS system enforced • Employment and decent work regulations
Support for implementing policy (enforcement mechanisms in place)
<ul style="list-style-type: none"> • Risks and constraints identified and minimized • Gender-sensitive implementation strategy drafted for the national/local context comprising implementation matrix • Institutional arrangements • Monitoring and evaluation system • Checklist of policy review process • Feedback from stakeholders in the value chain
Fisheries and aquaculture legal and regulatory framework
<ul style="list-style-type: none"> • Fisheries regulatory framework governing food safety, quality assurance and control (including PAHs)

TABLE 20
Checklist for programme designers and managers of FTT infrastructure

Checklist
Situation analysis
<ul style="list-style-type: none"> • Significance of fisheries and aquaculture for the country/area • Structure and characteristics of the fisheries and aquaculture sector at national level • Prevailing fisheries status and potential: main fish species targeted, catch levels and ecosustainable potential • Prevailing fishing and post-harvest practices • Fish distribution and marketing (including means of transport and market checkpoints, etc.) • Fish consumption habits and preferences • Market needs and requirements • Existing storage, processing, transport and market/sales infrastructure • Prevailing policy, legal and regulatory frameworks • Institutional arrangements (appropriate collaboration with relevant [non-, inter-] governmental agencies) • Extension efforts and follow-up • Statistical data system in place • Existing financial services
Effective participation and engagement of target stakeholders, including local communities and authorities to foster buy-in of FTT
<ul style="list-style-type: none"> • Stakeholder and community sensitization and education • Site selection • Allocation of sites and other amenities for the construction of FTT infrastructure
Capacity development and empowerment of value chain actors
<ul style="list-style-type: none"> • Training on good hygienic and manufacturing practices (GHPs and GMPs), functional literacy, entrepreneurial and financial education, marketing communication and basic marketing techniques • Incorporating gender in all training and stakeholder activities • Development and/or upgrading of skills of extension workers and field officers in community approach techniques such as participatory rural dialogue and appraisal • Access to markets and market information by value chain actors • Training of local artisans
Establishment and management of FTT infrastructure
<ul style="list-style-type: none"> • Practical experience and skills on FTT kilns of those tasked to design and construct them • Effective participation and engagement of future FTT users (especially women) in the design of the FTT • Testing and demonstration of facilities and equipment during installation • Establishing/strengthening of professional groups through training and FTT design activities to foster buy-in and economies of scale • Management arrangements and partners' respective roles and responsibilities • Memorandum of understanding between partners • Collective monitoring modalities, including the benefits each actor or group of actors is likely to reap • Data collection and monitoring system for FTT activities and connected activities • Documentation of FTT effects compared with traditional smoking kilns
Promotion of FTT and its products
<ul style="list-style-type: none"> • Sensitization and education of the public at large on the comparative advantages of the FTT and its products • Ecology and green energy alternatives • Packaging and labelling • Alternative income-generating activities • Marketing support and product differentiation involving processors and fishmongers • Marketing campaigns through media and information and communication technology supports • Dedicated market stalls for FTT products • Potential niches for FTT products • Marketing division within the Ministry of Fisheries • Trade fairs (at local, national and regional levels) • Risk assessment to substantiate claims of improved safety
Widespread dissemination of FTT
<ul style="list-style-type: none"> • Institutionalization of lessons learned from previous FTT projects and project stages • Culture of experiential learning • In-country exchange visits between FTT projects, and exchange tours abroad to similar FTT projects for fish value chain actors

Phase 1: Project planning and design

Lesson 1: Successful sequencing for the introduction of the FTT in a given context enhances uptake by value chain actors.

Overview

Lessons learned in countries where FTT platforms have been set up such as Burkina Faso, Côte d'Ivoire and Ghana, show that prior to setting up these platforms, certain preparatory activities would ensure a much smoother uptake by actors along the value chain.

Background

Once the strategy and the comprehensive plan for the post-harvest fisheries subsector has been drafted and adopted by decision-makers, a two-pronged preparatory approach where each branch runs in parallel to the other is to be carried out.

The first branch includes:

- capacity building in functional literacy and accounting, access to market information, business management and natural resource management solutions for potential FTT unit users;
- identifying existing socioprofessional groups, women's groups, cooperatives and providing support to render them more cohesive and efficient, or setting up groups around existing income-generating activities that will then be able to manage the FTT platform, along with training in good handling, storage and packaging practices (Herbel *et al.*, 2012).

The second branch comprises:

- setting up a post-harvest unit within the ministry or department of fisheries and aquaculture to spearhead post-harvest activities in the country;
- training the ministry of fisheries and aquaculture staff located at district level in fish post-harvest extension delivery.

Both sets of actors would then be brought together to discover the FTT and proper storage facilities in order to then co-design the type of kilns that correspond to local needs and customs, but they can also incorporate the different technological elements of this new technology.

Recommendation

- Adopt a sequencing approach for the introduction of the FTT in a given context as this enhances uptake by value chain actors.

Lesson 2: Effective stakeholder and community participation and engagement in all phases of FTT projects increase the actors' sense of ownership and chances of success.

Overview

Effective participation of key stakeholders (especially the local communities and authorities) in all phases of FTT projects from site selection to installation, operation, monitoring and evaluation is crucial. This enhances their sense of ownership and appropriate use of the FTT unit put at their disposal, as well as the chances of success, particularly when the installation, the management and stakeholders' responsibilities and contribution modalities have been clarified from the outset. In contrast, a top-down approach is doomed to failure, while the dependency syndrome created by an external full grant of equipment from outside the community should be discouraged.

Background

Site selection – Studies conducted in Côte d’Ivoire (Anoh, Ouattara and Ossey, 2016; Anoh *et al.*, 2018) revealed that positive FTT effects are more noticeable among fisheries communities with a high concentration of fish smokers (such as Grand-Lahou) compared with those where processors tend to smoke fish on an individual basis (such as Braffedon). As discussed above, the kilns’ distance *vis-à-vis* the potential users’ home is another determining factor for their adoption.

The nature of the soil and the site area on which the FTT infrastructure is to be built is also an important factor to consider in terms of slope, viability against flooding, contamination and pollution risks. Each and every time, it is fundamental that the intended community participates in the site selection, as their experience and indigenous knowledge of the locations may be useful in suitability screening.

Allocation of sites and other amenities for the construction of the FTT infrastructure – It is reported that in all the country case studies on which this document is based, sites harbouring the FTT infrastructure are located on communal lands obtained free of charge for the related projects.

For example, thanks to the decentralization process in Côte d’Ivoire, the engagement of central competent and local government institutions has basically comprised structuring producers in groups, allocating sites and ensuring their servicing (e.g. improving the existing pathways, installing/scaling-up a drinking-water supply system), and funding part of the infrastructure (e.g. the warehouses harbouring the platforms in Guessabo and Marcory-Anoumabo by the Regional Councils of Haut-Sassandra and Marcory Municipality, respectively) (Ziehi, 2016).²⁴

In Angola, local communities also obtained plots of land for the establishment of post-harvest technological platforms not only in Ngolome, but also for those planned in Mulondola and Val do Loge, in addition to providing ancillary jobs (masonry, metalwork and carpentry) for the first platform. The latter two sites were jointly selected by the competent authorities, local authorities and FAO (Mindjimba, 2017b). However, there is no evidence that the target groups also participated in the process.

Recommendations

- Adopt a participatory approach with key stakeholders in all phases of the development process of FTT projects.
- Facilitate and support stakeholder and community participation and engagement through adequate sensitization and education (see Lesson 10 below).
- Select the site to harbour the FTT infrastructure judiciously to foster it being reachable by the greatest number of potential users, and make sure that the intended community participates in the site selection. This generally means compromising among several criteria such as concentration of fish processors, distance, servicing and security.

Lesson 3: Empowering the target groups and developing or upgrading their capacities enhances their ability to run the FTT infrastructure made available to them.

Overview

Empowering the target groups and developing or upgrading their capacities is fundamental to enabling them to participate in decision-making processes regarding the FTT they have been given access to and to run it effectively. In general, the success or failure of the FTT depends on the capabilities of the processors and those of the personnel responsible for following up their activities and providing guidance

²⁴ The local authorities concerned comprise administrative, municipal, territorial and traditional authorities.

(e.g. correcting minor malfunctioning of the facilities and equipment in place). Empowering starts right from the first contact with the target groups, as this provides an eye-opening experience on the issues at stake, and an opportunity to gather their views and needs, address any misunderstandings and overcome distrust, acknowledge good ideas and best practices, etc. Women fish processors and traders in particular should be empowered, owing to their involvement in the fish value chain and their vulnerability (Rosenthal, forthcoming).

In fact, processors groups are not very functional with women preferring to smoke the fish at home, which allows them to have time to go about their household chores. One option to improve this is to strengthen group capacity and functionality while highlighting the benefits associated with collective actions. The economic vision of the fish processors groups must be built on concrete collective actions of smoking, marketing and capacity building.

Background

Despite the fact that fish processors and fishers are organized in cooperative societies, most of their activities (financing, purchase of raw materials, sales, etc.) are still done individually. Leadership conflicts often lead to a split of cooperatives into mini-cooperatives. Moreover, in most cases, women prefer to use this time to sell their products or deal with domestic chores rather than implement collective actions or take part in cooperative meetings, and this has a significant negative effect on group dynamics.

On the one hand, most cooperatives involve actors from several links in the fish value chain while relationships between these links have not been formalized, meaning that potential benefits are yet to be perceived and nurtured (Rosenthal, forthcoming).

On the other hand, cooperatives that have benefited from FTT platforms have been organized into a network that should form the basis for exchange and collaboration between these cooperatives. Nevertheless, women have not been mobilized to take on this initiative.

Thus, most FTT projects encompassed training of the intended target groups to enable them to implement the required good practices that ensure high-value products on the one hand, and to properly run the FTT infrastructure made available to them on the other. Some of these training activities are reviewed below.

In **Angola**, in addition to the training results achieved under TCP/ANG/3403 (FAO, 2016b), 41 officers and technicians from the administration were trained in fisheries data collection and analysis as part of a fishery frame survey under the Unilateral Trust Fund UTF/ANG/058/ANG (Tous, 2017). Although not specifically designed for that matter, this survey will eventually provide comprehensive and reliable data and information upon which the planned FTT platforms across the country and the exact types of platforms and their dimensions and capacities will be based.

Meanwhile, the Ngolome post-harvest technological platform has been erected as a national fisheries training centre. It is designed to serve as a reference and demonstration centre for the transfer of knowledge through on-the-job training (Mindjimba, 2017b). The aim is to make sure that the trainees can apply their newly acquired knowledge and skills and adapt them to the local environment when they return home by providing them with the necessary accompanying support. This has been the case of a group of women fish processors in Ngolome within the TCP/ANG/3403 after their exchange visit in Senegal. These women acted as a key driver of change, first within their community, then in other communities, showcasing how working together and better can provide greater benefits, a stronger leap than by acting individually. Their level of awareness of the use of the FTT enabled them to think of an alternative energy source from locally available materials: the dried fruit or pods of baobab trees.

In **Burkina Faso**, the capacities of three clusters of 50 women smokers were built in fish GHPs and GMPs as well as cooperative action and marketing (Akoun, 2018), as part of the aforementioned FAO FMM/GLO/103/MUL. In fact, the exploratory study carried out in this country before the establishment of the improved kilns and the gender-sensitive value chain study both showed that the existing women fish processors groups had no experience in jointly managing economic infrastructures, despite their potential advantages for members. Thus, in many contexts, this type of collaboration may be completely new for processors who have hitherto operated individually.

In **Burundi**, 30 fisheries group leaders (23 of them women) were trained in fish processing (mainly smoking with the FTT) and packaging as part of FAO TCP/BDI/3602.

In **Côte d'Ivoire**, some 2 500 women fish processors were trained in improved fish smoking techniques and GHPs either directly or indirectly through those who had participated in the said training as part of the FAO TCP/IVC/3501 (Diomandé, undated; Ziehi, 2016). However, supplementary or refresher training is needed, especially in the management and use of the existing units. In fact, in both Burkina Faso and Côte d'Ivoire, the dysfunctions observed during implementation of the FTT platforms showed that equipment management should be entrusted to clusters designated by the beneficiaries, at least for newly established groups. This learning process requires extension efforts and follow-up by the relevant ministry's technical structure at local level. In Côte d'Ivoire in particular, the CMATPHA on the FTT platform in Abobo-Doumé has a proven track record of group dynamics and business management compared with the other cooperatives running the FTT platforms in Braffedon, Guessabo and Marcory-Anoumabo. The former is so concerned about boosting its business and profits that its members tend to encroach on the interests of those in Marcory-Anoumabo, thereby weakening others' already fragile group dynamics.²⁵ It is important to include cluster-based or innovation actors and outstanding community leaders in training programmes.

In **Ghana**, the FTT has been included in the curriculum of the University of Ghana as a topic under Animal Products Processing Technology, a course offered by the Department of Nutrition and Food Science.

In **Guinea-Bissau**, 50 women fish processors around the established FTT platforms were trained in fish post-harvest techniques and the operation of the said platforms. Ten fisheries officers were also trained in GHPs and GMPs (FAO, 2016f; Ndiaye, 2015). A management committee was formed on each platform. However, efforts are needed to ensure that the project team and the target groups effectively monitor the platforms put in place.

In **Sri Lanka**, groups of women fish processors around the Unnichchai fishing community were trained in GHPs and fish handling techniques as part of the FAO implemented EU-SDDP.

As indicated above, the fact that FTT products and those resulting from traditional methods are sold on the same local and domestic markets and under the same conditions (as observed in Côte d'Ivoire, the Democratic Republic of the Congo and the United Republic of Tanzania) could slow FTT adoption. The only reported exceptions are observed on the FTT platform in Abobo-Doumé, where the CMATPHA targets lucrative outlets such as ministerial cabinets and a few institutional catering units, and in Sri Lanka where the price of smoked fish with the FTT is 1.6–1.8 time higher than that smoked with traditional methods. While structuring of FTT platform operators

²⁵ However, analysis of group dynamics reveals that, at present, not all these cooperatives effectively manage the platforms put at their disposal. The reasons for this stem less from the relatively young age of these cooperatives than their opportunistic set-up to gain access to a modern fish-processing platform. It is reported that the platform in Marcory-Anoumabo has been closed for the past six months and that the SCOOPS Tchanfé has been almost completely dismantled.

into cooperatives or professional groups incorporates the benefits derived from efficient economies of scale, the Côte d'Ivoire FTT project also provided simplified accounting training for the same categories of value chain actors. The project as a whole revealed that further strengthening skills in entrepreneurial development is also essential, and that comprehensive literacy, accounting and business management should be planned in partnership with the ministry in charge of women's affairs or adult education, depending on the context, as this is key to ensuring women's effective and efficient participation in the fish value chain (Rosenthal, forthcoming).

In Burkina Faso and Côte d'Ivoire, although steps were taken to set up clusters, and improve differentiation and marketing of FTT products at the platform level as well as establishing commercial relations with more profitable markets, the approach and the actual key elements leading to a successful uptake of these aspects still need to be refined. Much of this will depend on the actual coherence and strength of each cluster, group and/or cooperative.

Recommendations

- Draw inspiration from the prerequisites identified in Herbel *et al.* (2012) to create or transform professional groups into highly beneficial institutions:
 - bonding or intragroup relationships among small producers within organizations;
 - bridging or intergroup relations between small-producer organizations to create apex organizations;
 - linking or extra-group relations between small-producer organizations and market actors and policymakers.
- Adopt good practices, knowing that relevant cases suggest that effectiveness and sustainability depend on the following conditions:
 - perceived mutual benefits;
 - clearly defined rights and responsibilities;
 - transparency.
- Empower the target groups (including women fish processors) that will be given access to an FTT platform. Develop or upgrade their capacities and those of the agents responsible for following up their activities and providing guidance (in such areas as smoking techniques, using and maintaining FTT platforms and kilns, record-keeping, functional literacy, entrepreneurial and financial education, monitoring and marketing strategies, group dynamics and conflict resolution) in order for them to better carry out their productive activities and to run the infrastructure more effectively and efficiently.
- Empower platform champion women members through professional training to give them the knowledge and confidence to negotiate contracts with different markets than the ones they are familiar with, such as supermarket chains and the catering and hospitality sector.
- Revitalize the grassroots and umbrella organizations in each segment of the value chain and set up an intersegment organization and a channel of communication or consultation between the segments of the value chain's different levels.
- Set up institutional arrangements ensuring excellent post-harvest extension accompanying improved technology and adequate infrastructure, including proper storage facilities.
- Set up a system of record-keeping through the fisherfolk professional groups in order to bring about better resource management and a clearer understanding of the sector, allowing the development of the sector to be planned in a sustainable and profitable way.

- Allow only well-structured and organized socioprofessional groups to run the FTT infrastructure in communal settings.
- Facilitate the structuring and organization of beneficiary groups.

Lesson 4: The technical specifications (especially the capacities), construction and dissemination of future FTT prototypes must be consistent with the prevailing fisheries status and potential as well as existing practices and market needs.

Overview

In any context where the FTT is to be introduced, the design of the prototypes should be commensurate with the prevailing fisheries status and potential as well as the needs of the target groups and consumers. It is equally imperative to adapt the facilities and equipment to the prevailing local environment (including fishing and post-harvest practices, the main fish species targeted, and catch levels and potential) and market needs. This requires reliable data and information (Mindjimba, 2017b). Bjorndal, Child and Lem (2014) point out that “sustainable resource management and better regulatory framework practices are a necessary condition for small-scale value chains to be sustained. [It is also crucial] to always consider and safeguard the impact that increasing trade will have on local food security.”

Background

The widespread dissemination of FTT kilns will inevitably require more fish, and hence increase the pressure on fisheries resources. As discussed in Chapter 2, in contexts where there is a deficit in fisheries production (such as Benin, Cambodia, Côte d’Ivoire, Ghana, Nigeria and Togo), the FTT should replace existing drying and smoking devices with a view to improving working conditions for processors, reducing PHFLs and providing safer fishery products to consumers. In other contexts with relatively abundant fisheries resources but significant PHFLs and dire working conditions for fish processors or poor processing techniques, disseminating the FTT should be widely promoted, as it is a very efficient tool for addressing all three of these issues.

The supply gap should be filled by fish from other sources, including responsible aquaculture and imports. The often-conflicting objectives and interests of these sources should be balanced (Mindjimba, 2017a). However, field observations showed that most FTT kilns in place (in Côte d’Ivoire and the Democratic Republic of the Congo in particular) were underutilized (Mindjimba, 2017a; Bungubetshi *et al.*, 2018).²⁶ More lucrative markets for FTT products also need to be explored. To this end, the CMATPHA in Côte d’Ivoire has adopted more aggressive marketing strategies to boost sales of its FTT products at the platform in Abobo-Doumé, including the possibility of exporting to the European Union (Member Organization) (Mindjimba, 2017a).

To date, as indicated above, FTT products and those resulting from traditional processes are generally sold on the same marketplaces and under the same conditions and thus compete with each other, and often the consumer is not aware of the difference between the two types of products in terms of quality and safety (Mindjimba, 2017a; Mindjimba and Tiotsop, 2018).

²⁶ In Côte d’Ivoire, CMATPHA members on the platform in Abobo-Doumé purchase frozen fish from nearby cold stores. They also signed an agreement in 2017 with an industrial vessel owner to obtain raw fish for their needs.

Recommendations

- Set up a sound statistical data system in support of the processing domain and market information conducive to a consistent commercial partnership establishment.
- Match the design of FTT prototypes with the prevailing fisheries status and potential as well as market needs of the local/national context and prevailing customs, as has been done in Burkina Faso with the FTT-Dafing kiln.
- Improve the product (fresh and smoked fish) quality by increasing women processors, fishmongers and also fishermen's awareness to transform bad practices with capacity development programmes on good fishing practices, handling and hygiene, especially at the level of fishing.
- Document reduced fish loss and waste thanks to the FTT, thereby easing some of the pressure on fisheries resources.
- Ensure that FTT products meet market needs and requirements, particularly in terms of traceability, packing consistent volume, product quality, and frequency and regularity of supplies.

Phase 2: Implementation and monitoring

Lesson 5: Only those with the proper practical experience and skills on FTT kilns should be tasked with designing and constructing them and training others in their use.

Overview

FTT kilns should only be designed and constructed by people with prior practical experience and skills. These people should also be able to train intended users, especially for community kilns as the effective use of these kilns and low PAH levels heavily depend on their design and proper functioning, following testing and demonstration.

Background

Field investigations in Cameroon showed that most of the installed FTT kilns were not effectively used (the two FTT Altona kilns installed in a warehouse at Dockyard in Limbe had never been used), and those that had been trialled once were abandoned by the target groups (the two FTT Banda kilns in Londji). The main reasons for the non-use of these kilns include: the top-down approach adopted; low participation of the local population in the process; inappropriate design and technical flaws of the FTT; absence of testing and demonstration during installation; and lack of guidance and follow-up.²⁷

Recommendations

- Develop and/or upgrade the skills of the extension workers and field officers in community approach techniques such as participatory rural appraisal.

²⁷ Below are some examples of inappropriate FTT design (Mindjimba and Tiotsop, 2018):

- Mismatch of the prototype with the target fish species (the FTT Banda would have been more appropriate for small pelagic bonga, *Ethmalosa fimbriata* and *Sardinella maderensis*, than the FTT Altona – these two low-value species are traditionally smoked in an upright position in Cameroon's coastal fisheries communities, thus imposing a minimal distance between successive trays; they are primarily destined for domestic and subregional markets where they are cooked and consumed peeled, hence, the FTT does not add much value to them).
- Metal parts (ember furnace, fat-collection tray, indirect smoke generator system and hot-air distributor) not protected by an antirust coat, especially in coastal areas, thus resulting in burnt product.
- Chimney not functional, exposing the processors to direct heat, burns and smoke, whereas a properly functioning FTT system prevents these hazards.

- Task only those with the proper practical experience and skills in FTT kilns with designing and constructing them and training others in their use, especially those destined for communities.
- In order to have local building expertise, ensure proper training of local artisans.
- Test and demonstrate the facilities and equipment during installation.

Lesson 6: Adopting a stepwise approach in implementing FTT projects increases chances of success and minimizes risks of failure.

Overview

Organizations should adopt a stepwise approach while implementing FTT projects so as to take corrective action early in the project inasmuch as the FTT is relatively new and yet to be mastered.

Background

In Côte d'Ivoire, the design of the four pilot FTT platforms and their kilns has been moulded to the local environment and needs from site to site. Examples of such design adaptations include smaller mesh size of trays to smoke small fishes and shorter kilns based on observations made by the users on previous prototypes (Mindjimba, 2017a). Other examples are: the FTT-Dafing (a redesigned prototype involving some key FTT components added to the round-shaped jar traditional kiln – see Figures 18 and 21) that FAO is piloting in Burkina Faso to suit the local needs and trigger adoption; and the detachable FTT in Nigeria (Chapter 2). The Government of Angola has also adopted a similar stepwise approach in establishing post-harvest technological platforms across the country.²⁸

Conversely, the pilot FTT kilns in Cameroon were installed immediately from one site to another without learning any lesson from prior experiences – this, combined with the other reasons mentioned, led to the non-use of these kilns or their abandonment by the target groups after a few trials by them.

Recommendation

- Adopt a stepwise approach in implementing any FTT project, as this increases chances of success and reduces risks of failure.

Lesson 7: FTT management arrangements need to be clearly defined and partners' respective roles and responsibilities in that regard clarified early in the project.

Overview

Management arrangements (preferably co-management) of any FTT infrastructure should be decided upon, followed by a timely and transparent process to hire personnel, ensuring that the people appointed can take up their duties on time to avoid unnecessary delays. These management arrangements should specify whether the said infrastructure will be operated solely by the administration or competent authority, POs or clusters of innovation or outstanding community leaders, a private or cooperative enterprise, or jointly. It is important that the partners' respective roles and responsibilities be clearly spelled out through contractual arrangements such as a memorandum of understanding (MoU) or a protocol agreement. Experience with the management of community-based infrastructure (Ben-Yami and Anderson, 1985)

²⁸ The two platforms planned in Mulondola and Val do Loge will be established one after the other based on the lessons learned from the Ngolome platform (Mindjimba, 2017a; Mindjimba and Tiotsop, 2018).

teaches the lesson that dishonest or inefficient operators should be dismissed, and that this should be provided for in the contractual arrangements.

Background

The Ngolome post-harvest technological platform in Angola, for example – designed to serve as a reference centre and a pillar tool for knowledge transfer through on-the-job training – is financially supported by the government in partnership with a private enterprise through a protocol agreement with representatives of the riparian fisheries associations (Mindjimba, 2017b).

Recommendations

- Decide on the management arrangements of existing or future FTT infrastructure by clarifying partners' respective roles and responsibilities in that regard early in the project (in terms of hygiene, maintenance, collection and management of user fees/finance, etc.).
- Select only honest and efficient operators (based on their reputation) to run the infrastructure and formalize the contractual arrangements through a MoU or protocol agreement; alternatively, the value chain actors could select among themselves the best-qualified groups.
- Ensure provision (under the MoU) for dismissal of operators whose honesty and efficiency are questioned or not proved.

Lesson 8: Empowering women fish processors in carrying out their productive activities and in managing their income strengthens their autonomy.

Overview

Dialogue mechanisms should be initiated to find constructive and peaceful ways of transforming family dynamics by putting forward livelihood improvements before bringing in microfinance institutions in order to preserve family cohesiveness and to efficiently make use of formal credit instruments.

Fish smoking and marketing conditions are still very precarious. Thus, adopting a value chain approach that focuses on market dynamics includes improving the quality of fresh and smoked fishery products and redirecting them to end markets at the national level. This calls for awareness-raising and capacity-building actions of value chain actors along with good smoking practices.

Background

In most environments, women processors' productive activities are anchored in family dynamics in which they have little decision-making power. They face an inequitable distribution of household expenditures and underinvest in their production equipment. These gender constraints usually negatively affect investments that women beneficiaries could make in developing their processing/marketing activities (Rosenthal, forthcoming).

On a practical level, information should be drawn from a study identifying the differences in men's and women's individual priorities, preferences, needs, knowledge and decision-making power are relevant for the uptake of the FTT (FAO, 2018c). The study would also examine how age, gender, nationality and poverty may be factors of discrimination for access to resources and markets.

Authorities in Côte d'Ivoire requested FAO support in drafting and implementing a strategy that would enable them to transmute the Ivorian fisheries value chain into a gender-sensitive sector, thus ensuring women's equal participation. Relevant content of the strategy that may be useful in other contexts is found throughout this document.

In general, one of the incentives for these practices to be fully taken up is a more remunerative price for FTT products on certain markets (other incentives can include better working conditions, more fish smoked in less time, products with a longer shelf-life, etc.), resulting in better livelihoods for women processors and their communities. Given consumer awareness, preferences and purchasing power, more costly smoked fish products must meet higher health and hygiene standards; this means that, at present, the main market for improved smoked products is not the immediate local market but the urban one and formal retailing facilities near the production sites (Rosenthal, forthcoming).

Searching for promising markets and using a contracting process to sell higher-quality smoked products would also stimulate more sustainable collective action and good community-based management.

FAO (2016h) has produced a guiding framework for developing gender-sensitive value chains (as part of the Organization's series on sustainable food chain development). The aim is to "facilitate the systematic integration of gender equality dimensions into value development programmes and projects" (FAO, 2016h). It is essential that policy- and decision-makers integrate these dimensions into FTT value development, especially women's specific concerns owing to their overwhelming involvement in this subsector, and their vulnerability and limited access to productive resources compared with men. This will help ensure sustainable development of fish value chains.

Recommendations

- Empower women fish processors in carrying out their productive activities (fish processing and marketing) and in managing their income through tailor-made training programmes.
- Devise ways to ensure equity in all activities.
- Facilitate women fish processors' access to microcredit for productive activities.
- Adopt a gender-sensitive value chain approach that focuses on market dynamics.
- Identify and explore more lucrative markets through contract-selling and sustainable practices, as this improves marketing conditions.

Lesson 9: Linking all actors to markets by supporting marketing and product-differentiation activities enhances livelihoods.

Overview

Exchange experience visits organized during FTT dissemination projects highlighted the need for a link between higher-quality products resulting from technological innovations and the market. This was confirmed during discussions at the Elmina meeting.

Background

First, the quality of the fish is related to fishing practices and preservation conditions implemented by the fishers. These factors influence all of the related segments, including the income fishers make from fishing. Second, products should at least meet potential customers' requirements and at best offer new and more appealing products that ideally also create more added value for all actors along the value chain. Therefore, articulating the market and production interaction is fundamental to ensuring that the value chain remains competitive and dynamic (Rosenthal, forthcoming) and that FTT products sell at higher prices than those derived from traditional processes. The two key drivers of the "deadlock" regarding FTT products observed in the country case

studies stem from the fact that there are no promotional campaigns or dedicated and appropriate locations to market them.

Moreover, markets take place on set days, and market authorities often do not take into consideration supply and population dynamics over time, and they do not consult with market sellers to hold the market on days that ensure that fishery products are sold as and when they are fresh.

Recommendations

- Facilitate the organization of raw material purchases.
- Support management fish smoking and storage platform as well as inputs, quality assurance, labelling and packaging practices, and volumes of products sold.

Lesson 10: Sensitizing and educating the public at large on the comparative advantages of the FTT and its products enhance the likelihood of product buy-in and consumption.

Overview

The performance (technology, quality and safety of products) of FTT kilns is now formally established. Public awareness campaigns need strengthening to sensitize and educate the general public on the comparative advantages of this new technique over traditional fish smoking systems, and particularly on food safety issues and higher-quality products available on the market. Consumers in particular should be helped to understand that these products are good value for money and should attract premium prices to reward compliant producers. It is vital that processors, for their part, be sensitized with evidence-based data on the need to mind their health in terms of opportunity cost for diseases associated with traditional fish smoking systems and the environment.

Background

Field observations have revealed that some consumers (e.g. in Côte d'Ivoire and the Democratic Republic of the Congo) are hesitant to purchase FTT products because of their "paleness" or lighter colour (wrongly attributed to an insufficient smoking process, while the product actually has a golden colour and is shiny when cooking oil has been applied prior to smoking) and would prefer the traditionally dark brown and blackish colour (actually charred and containing high amounts of tar-particle products) to which they are more accustomed (Mindjimba, 2017a). It was also observed that some consumers in Burkina Faso and Côte d'Ivoire were not aware of the availability of FTT products and where to find them (Akoun, 2018), and this constitutes a challenge for the marketing of these products.

In Côte d'Ivoire, communication and promotional materials for these products have been developed (FAO didactic videos and other videos produced by local television channels, flyers, kakemonos) but have yet to be presented to the general public.

Recommendation

- Sensitize and educate the general public on FTT products benefits, including their value for money and comparative advantages through awareness campaigns and relevant channels such as radio and television programmes, press campaigns, participation in fairs, and awareness caravans.

Lesson 11: Developing ecology and green energy alternatives and alternative income-generating activities enhances value chain actors' economic and climate change resilience.

Overview

People across the Sahel and in other parts of the world face many formidable challenges because of desertification and climate change. Women fish processors need two resources provided by nature on a daily basis: safe water to produce ice and clean and prepare the fish; and wood to smoke the fish that is not sold fresh. Both resources are scarce in this type of setting. Moreover, throughout developing countries, women and girls are often solely responsible for gathering fuel and for cooking and providing food, although in certain contexts, men and boys also gather wood. Thus, women's involvement in decision-making processes on more sustainable natural resource usage is critical.

Background

Sunlight is readily available in developing tropical countries where fish hot-smoking is traditionally practised, allowing for guaranteed solar energy, when harnessed with solar panels, which can power electric equipment such as refrigerators, freezers and ice-making machines.

Experiments to use a combination of wood and electric power for smoking fish should be conducted in order to assess the feasibility of reducing the use of wood while preserving the current flavour and texture of smoked fish.

Moreover, other alternative sources of energy such as biogas produced with agricultural, animal and fish waste that could be used for cooking, drying and smoking activities should also be explored. In addition, a comparative analysis should be carried out that would examine technology manufacturing, maintenance and sustainability specifications and costs as well as ecological, economic and ease-of-use issues.

Depending on the context, certain wood species are more easily accessible and inexpensive than others but may not be used by fish processors. Their use in other forms (dry wood, coal, etc.) should be explored after testing by examining the following parameters: combustion level (full or incomplete); heat distribution; cooking temperature; smoking temperature; cooking and smoking times; percentage of water loss in fish; smoked fish texture; maximum amount of oil recovered per kilogram of fish (depending on fat content); ease of operation; appreciation of smoked fish quality; toxicity; carbon footprint; and sustainable forestry practices.

In order to accompany sustainable use of both fisheries and forestry resources, dialogue should be fostered with women processors along with actual examples showing how this may positively affect their lives.

As indicated above, in addition to fish and meat processing (for both members and non-members) and trade, women fish processors cooperatives in general and the CMATPHA in particular also strengthen the use of the other functions, taking advantage of the other benefits of the FTT, including the diversification of products (oil, bakery, sausage, dried fish, other animal products such as smoked chicken, pork, etc.) and an internal savings and a loan system. Moreover, various ancillary job opportunities to craft FTT components have been created around the platforms for local artisans. As such, the construction of FTT kilns favours technology transfer to these local artisans (Mindjimba, 2017a).

Recommendations

- Develop ecology and green energy alternatives.
- Develop alternative sources of IGAs as this enhances value chain actors' economic and climate change resilience.

Lesson 12: Project teams and sponsors need to effectively monitor FTT projects.***Overview***

By effectively monitoring implementation, the teams and sponsors can take corrective action and make timely necessary adjustments throughout the project. The aim is to improve the performance of ongoing projects and the planning of later project stages and future projects, and to prevent or minimize risks for future projects.

In addition, evidence-based data can guide the decisions of both fish smokers and consumers, and they can also be used to support public awareness and consumer education so that people are able to make informed purchasing decisions and change their behaviour towards choosing good-quality products.

Background

With few exceptions (e.g. appointment by the FAO Country Office in Côte d'Ivoire of two outreach young fisheries professionals for the guidance of women fish smokers on two of the four pilot FTT platforms in Braffedon and Guessabo and monitoring of their activities), observations gathered from the field show that, to date, monitoring of most projects has been done remotely.

Recommendations

- Set up a collective monitoring mechanism by the local extension services and project team; indeed, projects must include effective monitoring by teams and sponsors of FTT platforms management and use, and this must be planned and budgeted in a flexible manner that allows the time necessary to reach good and sustainable results; this implies that local authorities be given the means to honour this commitment after the closure of the development project.
- Define and reach consensus beforehand on monitoring modalities, including the benefits each actor or group of actors is likely to reap.
- Set up a data collection and monitoring system for FTT activities and connected activities.
- Document the effects of technological innovations as compared with traditional smoking kilns.

Phase 3: Evaluation***Lesson 13: Institutionalizing lessons learned and strengthening the culture of experiential learning are good practices for success.******Overview***

Examples of learning in the context of FTT interventions include designing new prototypes according to the local environment and market needs, improving processing methods, and revising national fisheries and aquaculture policies, legislations and regulations.

Background

Experiences learned from previous FTT prototypes can be shared, discussed, analysed, reflected and applied in subsequent prototypes before being disseminated. To this end, study tours to similar projects were organized to Senegal (in 2013) and the United Republic of Tanzania (in 2014) for groups of Angolan artisanal fishers, women

fish processors and extension workers to Côte d'Ivoire for 4 Ghanaian women fish processors in 2016 and 4 from Burkina Faso in 2017.²⁹

Recommendations

- Institutionalize the lessons learned.
- Strengthen the culture of experiential learning in the FTT development process.
- Organize in-country exchange visits between FTT projects, and possibly exchange tours abroad to similar FTT projects, for fish value chain actors.

Box 1 summarizes preconditions for success and lessons learned from FTT projects in the selected country case studies under review, while Annex 2 further summarizes these lessons together with the critical success factors, primary challenges and recommendations for later FTT project stages and future projects.

At the policy level, regulations, a strategy and implementation plan consistent with the principles of the Code and the SSF Guidelines should be elaborated regarding sustainable resource management and good practice along the fisheries value chain.

Integrating and implementing specific activities will be instrumental in promoting gender equality in the fish value chain, including decent work and sustainable environment practices that improve fish value chain actors' livelihoods and provide a framework to information, awareness raising and advocacy actions.

POLICY IMPLICATIONS

Fisheries and aquaculture, perhaps more than any other type of food production system, call for a careful balance between the local and the global dimensions of food security (i.e. availability of safe and nutritious food, accessibility in terms of physical and economic affordability, utilization or direct human consumption of essential micronutrients, and stability over time), given that the overall natural ecosystem of oceans and waterbodies relies completely not only on humans' fishing behaviour but also on their approach to ecology. Every living being on this planet is made mostly of water and relies on water in some form or other for its survival. When water is contaminated or polluted by extraneous "additions" such as plastic, the ecosystem faces challenges for its survival, and fisheries and aquaculture are affected as a result.

This requires that all policy decisions and implementation endeavours fully integrate long-term eco-sustainability so as to guarantee healthy fish availability for present and future generations. The international policy environment related to fisheries, and more specifically capture fisheries, has embedded this in its instruments and guidelines for a number of years and yet much remains to be done, including but not only for post-harvest practices. Perhaps the importance of post-harvest activities is best understood when considering that for every fisher or fish farmer in SSA and Asia, there can be at least ten dependent people ashore. These include families (for food), fishmongers at the landing site and at the fish market, hawkers, retailers, transporters and fish eateries and restaurant owners and workers, as well as boat builders, and input suppliers for fishing and processing activities. Do the existing fisheries and aquaculture policies mainstream FSN and promote the FTT? How can policymakers and development practitioners internalize these policy instruments? How could they address the shortcomings identified in the FTT's introduction and dissemination process? These are some of the issues the present section address, noting that all the evidence presented thus far should provide a launch pad for governments to demonstrate their commitments to the cited international and regional policy instruments.

²⁹ The study tour to Senegal dealt with responsible fishing practices and fish preservation and processing as well as valorization of fishery products and by-products, the one to the United Republic of Tanzania with small-scale fisheries (SSF) development including challenges and mitigation measures (Anon., 2014). The study tour to Côte d'Ivoire focused on the structuring of groups and functioning of FTT kilns (in Abobo-Doumé and Marcory-Anoumabo) (FAO, 2017e).

BOX 1

Preconditions for success and lessons learned from FTT projects in selected sub-Saharan African countries**Preconditions for success:**

- Precondition 1: The superiority of the FTT over traditional systems for smoking fish is a necessary but not sufficient condition for the adoption of this new technology in order to reap the anticipated benefits. Other conditions must be taken into consideration, including the prevailing business environment and consumer behaviour and awareness concerning FTT and traditional products.
- Precondition 2: The FTT is most likely to be successfully introduced in a country and to achieve its stated goals when food security and nutrition are embedded in national fisheries and aquaculture policies and enforcement is effective.

Lessons learned:*Planning and design*

- Lesson 1: Successful sequencing for the introduction of the FTT in a given context enhances uptake by value chain actors.
- Lesson 2: Effective stakeholder and community participation and engagement in all phases of FTT projects increase the actors' sense of ownership and chances of success.
- Lesson 3: Empowering the target groups and developing or upgrading their capacities enhances their ability to run the FTT infrastructure made available to them.
- Lesson 4: The technical specifications (especially the capacities), construction and dissemination of future FTT prototypes must be consistent with the prevailing fisheries status and potential as well as existing practices and market needs.

Implementation and monitoring

- Lesson 5: Only those with the proper practical experience and skills on FTT kilns should be tasked with designing and constructing them and training others in their use.
- Lesson 6: Adopting a stepwise approach in implementing FTT projects increases chances of success and minimizes risks of failure.
- Lesson 7: FTT management arrangements need to be clearly defined and partners' respective roles and responsibilities in that regard clarified early in the project.
- Lesson 8: Empowering women fish processors in carrying out their productive activities and in managing their income strengthens their autonomy.
- Lesson 9: Linking all actors to markets by supporting marketing and product-differentiation activities enhances livelihoods.
- Lesson 10: Sensitizing and educating the public at large on the comparative advantages of the FTT and its products enhance the likelihood of product buy-in and consumption.
- Lesson 11: Developing ecology and green energy alternatives and alternative income-generating activities enhances value chain actors' economic and climate change resilience.
- Lesson 12: Project teams and sponsors need to effectively monitor FTT projects.

Evaluation

- Lesson 13: Institutionalizing lessons learned and strengthening the culture of experiential learning are good practices for success.

To do so, the section summarizes some of the existing instruments that encompass post-harvest issues, how they integrate ecological, health, socio-economic, fisheries community and institutional sustainability, what has been accomplished in adopting and applying these according to a few specific contexts, how the fact that women constitute the large majority of actors in this portion of the sector is taken into

consideration, and potential gaps. While focusing on how the FTT may be further disseminated successfully in Africa and Asia, the section first examines how the policy environment supports:

- the best ways to reduce post-harvest losses and waste;
- the embedding of long-term natural resource management and green energy practices;
- the embedding of FSN in national fisheries and aquaculture policies;
- the development/improvement of distribution and marketing systems, along with enabling the existence of collective schemes for efficient economies of scale;
- professionals, and particularly women, in maximizing the value addition in post-harvest fisheries.

The second part of the section examines how these five matters have been integrated in policy instruments at the national level and whether this has been followed by on-the-ground changes. It further identifies the remaining gaps before elaborating a series of practical recommendations that lead to good governance of the post-harvest fisheries and aquaculture sector, with an emphasis on hot-smoke processing.

International instruments

Historically, at international policy level, the General Principles of the Code of Conduct for Responsible Fisheries (the Code) (FAO, 2012d, 2015a), adopted in 1995 by the FAO Conference (FAO, 1995), asserted that:

Recognizing the important contributions of artisanal and small-scale fisheries to employment, income and Why food security, States should appropriately protect the rights of fishers and fishworkers, particularly those engaged in subsistence, small-scale and artisanal fisheries, to a secure and just livelihood, as well as preferential access, where appropriate, to traditional fishing grounds and resources in the waters under their national jurisdiction.

FAO followed through with a number of initiatives on the ground, including two subregional programmes:

- i. The Implementation of a Regional Fisheries Strategy for Eastern and Southern Africa and Indian Ocean countries (comprising 19 countries: Burundi, Comoros, the Democratic Republic of the Congo, Djibouti, Eritrea, Eswatini, Ethiopia, Kenya, Madagascar, Malawi, Mauritius, Rwanda, Seychelles, Somalia, the Sudan, Uganda, the United Republic of Tanzania, Zambia and Zimbabwe), better known as SmartFish Programme. This programme was launched in February 2011 and is ongoing. It has, among other relevant achievements, as indicated above, supported the introduction of the FTT in the region, including in the United Republic of Tanzania in 2013–2014.
- ii. the Regional Fisheries Livelihoods Programme for South and Southeast Asia (RFLP), implemented between 2009 and 2013 in Cambodia, Indonesia, the Philippines, Sri Lanka, Timor-Leste and Viet Nam (FAO, 2012e, 2013a, 2013b). The RFLP sought to improve the livelihoods of fishers and their families while fostering more sustainable fisheries resources management practices.

Addressing the root causes of child labour in fisheries, poverty and food insecurity, and promoting decent work opportunities for adults, social protection and free education, present major challenges. To increase the knowledge base on child labour in fisheries and aquaculture and to provide assistance for policymakers and government authorities to address the difficult issue of child labour, FAO and the International Labour Organization (ILO) published Guidance on Addressing Child Labour in Fisheries and Aquaculture (FAO and ILO, 2013). This guidance points to

the importance of including hazards and specific risks for children in occupational safety and health assessments. Endeavours with fisheries communities should ensure that children receive adequate care and education, and are not involved in hazardous activities. Depending on the context, school feeding programmes may contribute to creating a favourable environment to remove children from the workforce and bring about sustainable change.

FAO has continued to move the SSF policy agenda forward with two important complements to the Code, the 2012 Voluntary Guidelines on the Responsible Governance of Tenure of Land, Fisheries and Forests in the Context of National Food Security and the 2015 SSF Guidelines (see Chapter 6). These two instruments are based on the principles of human rights and responsible governance to facilitate safeguarding and securing the livelihoods of tens of millions of people who depend on marine and inland capture fisheries and artisanal aquaculture. The SSF Guidelines focus specifically on:

- promoting social development;
- promoting decent work with the elimination of child and forced labour;
- providing occupational safety and health;
- ensuring adequate standards of living;
- fairly distributing benefits;
- facilitating participation of smallholder actors in decision-making along the value chain, including post-harvest and trade activities.

The 2016 session of the Committee on Fisheries recapped several of the SDGs, including SDG 5 and particular emphasis on women empowerment and gender issues, the elimination of all forms of exclusion and inequality everywhere (SDG 10), and sustained, inclusive and sustainable economic growth, as well as full and productive employment and decent work for all (SDG 8).

FAO's guiding framework to developing gender sensitive value chains (FAO, 2016h) stems from the FAO Policy on Gender Equality, which is in line with the Universal Declaration of Human Rights and the Convention on the Elimination of All Forms of Discrimination against Women, and states that:

Contextual understanding is essential to getting at the root causes that determine differing degrees of participation and benefit among value chain actors, and therefore to taking effective measures to bridge any gaps in access to resources.

Thus, exploratory post-harvest fisheries value-chain studies carried out to inform FTT implementation and adoption should truly integrate a gender-sensitive mapping of fish losses (FAO, 2018c), gender-responsive market research, gender-responsive sector and intervention selection, identifying key entry points for women in targeted value chains, strategies for enhancing women's participation and leadership, and gender-responsive results measurement systems. This should enable the improved design of tools that bring about a strong buy-in by women fish processors and good collaboration of men involved throughout the value chain.

These studies would also allow identification of the diversity of women and men as value chain actors with unique characteristics, abilities and aspirations. Moreover, the framework looks at these elements by taking into account that they are determined not only by gender, but also by ethnicity, social group, physical or mental disabilities and age, among other factors. By putting the individual, rather than technological or economic aspects, at the heart of the studies, the approach avoids adopting "one size fits all" solutions that overlook the differences and specificities of value chain actors.

The framework is complemented by the following regional commitments and instruments.

Regional policy commitments on food post-harvest loss and waste reduction and decent work

The **Malabo Declaration** – At the Twenty-third Ordinary Session of the African Union (AU) Assembly in Malabo, Equatorial Guinea, on 26–27 June 2014, the AU Heads of State and Government committed to ending hunger by 2025. To achieve this goal, they resolved to: (i) accelerate agricultural growth by at least doubling current agricultural productivity levels; (ii) halve the current levels of PHL; (iii) integrate measures for increased agricultural productivity with social protection initiatives focusing on vulnerable social groups through committing targeted budget lines within their national budgets; and (iv) improve nutritional status, and in particular, the elimination of child undernutrition in Africa with a view to bringing down stunting to 10 percent and underweight to 5 percent (AUC, 2014).

With regard to working conditions, the African Union Commission (AUC) and the New Partnership for Africa's Development (NEPAD) Planning and Coordinating Agency (NEPAD Agency) endorsed the Policy Framework and Reform Strategy (PFRS) for the Fisheries and Aquaculture Sector in Africa, which envisages that fisheries communities and fish workers have decent working conditions, live with dignity and realize their rights to livelihoods (AUC & NEPAD Agency, 2014). The strategy calls on member states to work towards the elimination of child labour and for the promotion of a conducive environment for youth employment, including access to financial services and youth-friendly health services.

Resolution on Sustainable Fisheries for Food Security for the ASEAN Region Towards 2020 – The Ministers of the Association of Southeast Asian Nations (ASEAN) – Southeast Asian Fisheries Development Center (SEAFDEC) member countries responsible for fisheries adopted this resolution at their Conference on Sustainable Fisheries for Food Security Towards 2020: Fish for the People 2020: Adaptation to a Changing Environment in Bangkok, Thailand, on 17 June 2011 (Anon., 2011). In particular, they resolved, without prejudice to their sovereign rights and their countries under relevant international laws and arrangements, to optimize the utilization of catch from water to market by reducing post-harvest losses and waste to increase fish supply and improve economic returns through promotion of appropriate technologies and facilities along the supply chain.

They further resolved to:

sustain the supply of fish and fishery products from the ASEAN region to improve food security, facilitate poverty alleviation, and improve the livelihoods of ASEAN people dependent on the harvesting, farming and marketing of fish and fishery products, by enhancing the necessary national fisheries policy, legal and institutional frameworks that encourages and support small-scale fisheries/farmers, including providing alternative livelihood opportunities” and “strengthen human capacity of relevant stakeholders through mobilization of resources and the harmonization of initiatives that support fisheries communities and governments, with a special focus on the women and youth.

Regional policy instruments on food safety

Volta Basin Specific Strategy to implement the Policy Framework and Reform Strategy (PFRS) for the Fisheries and Aquaculture Sector in the riparian countries' context – As outlined above (Chapter 6) in line with the PFRS and the Malabo Declaration, Volta Basin riparian countries developed a strategy in 2016 to mark their efforts in implementing the reforms endorsed by the instruments of the AU Summit aimed at reducing PHL (FAO, 2016c).

East Africa Standard for Smoked Fish – Overall, this standard demonstrates a willingness among governments in the East African Community (EAC) to improve smoked fish safety by including the matter in their harmonized standards. It is significant that PAHs are mentioned, given the assertion that the hazard may well be the most important process contaminant in hot-smoked fish. A few challenges are however identified as follows:

- Although the control of PAH is mentioned, the specific Codex documents dealing with PAH reduction (CAC/RCP 68-2009 and CODEX STAN 311-2013 [CAC, 2009, 2013]) were not included in the list of normative references.
- The standard states that the handling of “smoking materials” should guarantee low levels of the PAHs (Section 4.1.3). However, the term “smoking materials” was not defined.
- PAH limit (5 µg/kg) – The PAH marker for which this limit is set was not defined (i.e. whether B[a]P or PAH4), unlike in the standards of the European Union where limits are set for defined markers. However, it is likely that the marker targeted is B(a)P. The present value in the EAC standard was the limit for B(a)P set by the European Union (Member Organization) in force until September 2014 (Commission Regulation No. 835/2011, amending Commission Regulation No. 1881/2006).
- The limits set by the European Union (Member Organization) were based on risk assessments for PAHs within that subregion. It would be useful to establish whether the EAC limit was set on a similar premise (i.e. informed by a risk assessment in that context).

It is evident that adoption of the FTT within the EAC will guarantee that the subregion’s standard for PAHs is consistently met. This places a direct demand for policy support on the adoption of the FTT to ensure that the PAH food safety objective enshrined in the standard is met. Similar standards do not seem to have been devised for the other subregional groupings in SSA.

Policy implementation arrangements at the national level

It is apparent from the review of the existing sectoral policy, legal and regulatory frameworks governing fisheries and aquaculture in the country case studies that, globally:

- Traditional fish smoking and drying systems do not comply with the Codex Alimentarius Code of Practice (CAC/RCP 68-2009 [CAC, 2009]) regarding PAHs in particular.
- There is a need to improve the uptake of FSN in the national fisheries and aquaculture policies.
- There is a need to adopt a participatory approach in policy formulation.
- Potential for the introduction and widespread adoption of the FTT should be backed up by appropriate policy instruments (policies, laws, codes, acts, programmes, projects, etc.).

Policy options and recommendations

Governments may consider the following recommendations:

- Set up a statistics data collection system (if one does not exist yet).
- Collect fisheries and aquaculture data and information.
- Analyse the current status and potential of fisheries and aquaculture from the data and information gathered.

- Give due recognition of the importance of fisheries and aquaculture for food security, livelihoods and trade, and acknowledge the crucial role smallholders play in the use and management of fisheries and aquaculture resources as evidenced by the data collected.
- Conduct and document risk assessments for important food safety hazards along the fish value chain.
- Revise or develop appropriate national fisheries and aquaculture policies by incorporating FSN among the policy pillars:
 - adopt a participatory approach by engaging all interest groups and key stakeholders in the process;
 - ensure implementation through monitoring and evaluation;
 - mobilize adequate resources for follow-up of implementation as well as enforcement of existing legislations and regulations.
- Develop policy and institutional arrangements, including innovative partnerships, related to the functioning of value chains that empower smallholders, particularly women and youth, and their organizations, and that foster an effective and equitable role in the design and implementation of contractual arrangements.
- Promote institutional innovation and improve fisheries and aquaculture production systems.
- Promote inclusive participation in local food systems by encouraging competent authorities' engagement with all interest groups, including POs, consumers, and especially women and youth.
- Incorporate financing mechanisms to improve processing and storage equipment and facilities and their availability and accessibility across rural and urban areas to enhance fish food availability, quality and safety, and reduce seasonality of food insecurity and post-harvest fish loss and waste.
- Lower transaction costs by building trust along the value chain, improving infrastructure, transport and distribution systems, and enhancing access to useful, timely and transparent market information through information and communication technologies (ICT) and industry fora.
- Promote integrated and balanced approaches between policies and broader national strategies, including gender-targeted interventions to facilitate their support of markets linked to local, national, and regional food systems.

CONCLUSION

In summary, the 13 lessons outlined above have been captured from FTT interventions mainly in 8 country case studies (Angola, Burkina Faso, Cameroon, Côte d'Ivoire, the Democratic Republic of the Congo, Ghana, Sri Lanka and the United Republic of Tanzania). These lessons notably emphasize the importance of effective stakeholder and community participation and engagement in all phases of FTT projects, and the need to adopt a participatory approach in planning such initiatives as well as their implementation, also in order to judiciously select the intended site and to adapt future facilities and equipment to the local environment (including the prevailing fisheries status and potential) and market needs. Also warranted is the need to:

- empower the target groups (women fish processors in particular given their overwhelming involvement in fish post-harvest activities and their relative level of vulnerability);
- sensitize and educate the public at large and the target groups on the comparative advantages of the FTT, particularly its ability to offer higher-quality and safer products on the market;

- allow only those with practical experience and skills in FTT kilns to design and construct them, and to adopt a sequencing and stepwise approach for the introduction and implementation of FTT projects;
- allow only well-structured and organized groups to run any FTT infrastructure;
- build such groups' capacities to this end;
- clearly define the FTT management value chain approach and arrangements from the outset;
- develop ecology and green energy alternatives and IGAs;
- monitor and evaluate FTT project activities in order to take corrective action on time if need be.

Institutionalizing and using the lessons learned from FTT projects stemming from the country case studies should prevent institutions from repeating past mistakes, and instead allow them to replicate successes and achieve the desired results.

These lessons also have policy implications at the international, regional and national levels with regard not only to food security (including commitments on post-harvest loss and waste reduction) but also on the need to promote social development as well as decent work in the sector with the elimination of child and forced labour.

Chapter 10

Conclusions and recommendations

CONCLUSIONS

The significance of fish smoking in the tropics cannot be overemphasized. This utilization pathway generates fish as food that makes up 12 percent of global fish utilization, of which more than 60 percent is produced in African and Asian developing countries. However, the prevailing processing technologies in these countries present critical shortcomings in terms of food quality and safety. These challenges call for the development of more efficient and safer systems.

The FTT was developed as a solution responding to practically every challenge identified relating to fish processing techniques in the tropics. It mainstreams the Codex Alimentarius Code of Practice requirements specific to PAHs issued in 2009 (CAC/RCP 68-2009 [CAC, 2009]) and has, to date, brought about substantial benefits in 16 countries where it has been used. This FAO technology, considered one of its flagships, has also raised interest in other countries in Africa and Asia, which are thus contemplating introducing it in their fisheries and aquaculture post-harvest subsectors.

These benefits in ensuring food safety and environmental protection – while enhancing post-harvest operators' well-being (income and occupational safety and health) driven by key added components (ember furnace, fat-collection tray and external smoke generator) to correct the first generation of improved kilns' limitations – are demonstrated based on collated scientific evidence. A snapshot of the major characteristics of the FTT can be delineated as follows:

- From the **food safety standpoint**, which was the driver of its development: The FTT has proved its efficacy in controlling PAHs, compared with traditional smoking kilns spanning from the simplest type – a drum to a mud or rush hut – to the first generation of improved kilns, made up, among others, by the Chorkor, Banda and Altona, the latter being an adaptation from an existing device in the United Kingdom of Great Britain and Northern Ireland. Studies (Bomfeh *et al.*, 2016; Bomfeh *et al.*, 2018) have demonstrated that the FTT yields smoked products with PAH levels that are far lower than those in products from these other kilns. Moreover, whereas levels of hazards in FTT products were lower than the current maximum limits of the European Union, products from the first generation of improved kilns exceeded those limits by up to 33 times. The components of the FTT have varying degrees of impact on products' PAH levels; ranked from highest to lowest, the impact would be the: (i) type of cooking fuel; (ii) use or non-use of the fat-collection tray; (iii) use or non-use of the smoke filter; and (iv) type of material for generating smoke. The main public health concern of PAHs lies in their potential to cause cancer. The risk for cancer associated with fish smoked with the kilns under study was estimated using the MOE approach. The implications from the PAH risk assessments conducted to date are that the FTT is demonstrably an efficacious kiln that can help mitigate the consumer's risk of exposure to PAHs. Its MOE is far beyond 10 000, indicating minimal public health threat, hence requiring no risk management actions as opposed to the other kilns.

- From a **post-harvest loss reduction perspective**: The FTT yields smoked products with low PAH levels that meet regulatory limits. This quality improvement offers great gains in PHL reduction, as a loss in fish quality is considered a PHL (Diei-Ouadi and Mgawe, 2011). With an enhanced holding capacity (3–15 times that of preceding kilns) and reduced processing time (by 2–4 times compared with the first generation of improved kilns and up to 10 times compared with the traditional metal-drum kilns), more fish smoking sessions can be completed per day. This is a considerable asset during a bumper harvest, as larger throughput invariably contributes to reducing PHL, which is not the case with the limited capacity and longer fish smoking associated with traditional kilns. In addition, when the FTT is used as a mechanical dryer, fish can be dried irrespective of weather conditions, including during the rainy season or cloudy periods, which are significant driving factors of PHFL.
- **Environmental protection**: The FTT's environmental protection performance is demonstrated by its improved energy efficiency and much lower GHG emissions compared with traditional smoking systems, which burn massive amounts of fuelwood and therefore contribute to pollution by emitting large volumes of CO₂ into the atmosphere. This equates to reduced pressure on woody resources, with a fuel consumption of 0.8 kg per kilogram of raw fish to smoke as opposed to 3–5 kg with traditional systems (Ndiaye, Komivi and Diei-Ouadi, 2015; Ziehi, 2016). Similarly, heat-retention stones (e.g. siporex stones on FTT kilns) reduce the quantity of charcoal required by about 50 percent (Ndiaye, Komivi and Diei-Ouadi, 2015).
- **Decent working conditions**: The FTT safeguards fish smokers' health as it protects them from exposure to heat, burns, smoke and toxic gases, thereby making them less prone to eye, lung and skin diseases (Anoh *et al.*, 2018; Ndiaye, Komivi and Diei-Ouadi, 2015; Ziehi, 2016). In addition, the FTT reduces drudgery by shortening the processing time, and it is user friendly for processors once they have technically mastered its use. The need for less fuel reduces the time and frequency dedicated to fetching wood. All of these characteristics are significant, especially for women processors, who customarily face the challenge of combining their household chores with their fish business. It thus enables multitasking and saves time that can be allocated to other chores such as child care, food preparation, etc. Another benefit of the FTT is its ease of adaption to different sociocultural contexts, as illustrated by the FTT-Dafing, complementing the key sustainability factors of a valid technology.
- **Financial and economic benefits**: The financial and economic profitability of the FTT has been demonstrated (Mindjimba, 2017a). Its benefits include a swift return on investment, especially in more rewarding and structured markets, as well as the longer lifespan of its kilns. Its contribution to the local economy and the creation of ancillary jobs for local artisans and IGAs should also be considered. All its constitutive materials are found locally and can be assembled by local masons and blacksmiths. However, the upfront investment of from USD 381 (for the Chorkor FTT with one cooking compartment) to USD 1 668 (double-cooking compartment FTT Banda) for the FTT is relatively high compared with the other kilns, because of the cost of the additional components. Nevertheless, in a business environment, investment costs and subsequent benefits reaped or loss incurred need to be considered holistically. In the particular case of the FTT, it is essential to incorporate the potential for minimal opportunity costs from medical bills and/or having to regularly purchase medicines (whether from informal street vendors or formal pharmacies), the non-quality costs incurred when there is a detention and

destruction of non-compliant products by the competent authority, and the relatively lower operational costs linked to less fuel used. All these aspects are generally characterized by a quantitative data paucity because fish workers are known not to keep records.

Despite this overwhelming range of benefits that outweigh its drawbacks (mostly the immediate large investment and economies of scale challenge), some processors that had shifted to this groundbreaking technology are now reverting to their traditional processes. The upfront investment of the FTT may seem beyond the reach of the average smallholder fish processor in SSA and Asia. Besides this initial investment effort required, it is now established that the reasons for the abandonment of the FTT after a few trials by some processors stem from inappropriate planning, design and installation of the innovation, as well as the prevailing business environment. Indeed, lessons learned from the thorough understanding of the multidimensional factors in the selected developing countries linked to the use of this truly disruptive hot-smoking system suggest that some balance needs to be struck in relation to the overwhelming advantages and potential contextual drawbacks (trade-offs) that may affect its adoption. Indeed, the efficiency, sustainable adoption and wider-scale use of the FTT call for due regard to: (i) the significance of smoked and dried fish for food security and nutrition (FSN); (ii) a better understanding of the value addition of this flagship innovative technology developed as a response to a pressing need expressed by FAO Members; and (iii) the global and local business environment, including consumers' perceptions.

The nutritional attributes of fish as food are now well established, partly contributing to the patterns that people have never consumed as much fish as they do today, with per capita global fish consumption having doubled since the 1960s (FAO, 2018a). Factors such as the growing global population, increasing disposable income, and rising awareness about the health benefits of consuming safe seafood, have led to the rise in demand for fish and seafood across the globe, spurring market growth. Moreover, aquaculture production expansion is proportional to the increase in demand and is anticipated to supply more than 60 percent of the overall global fish and seafood demand by 2030.

For the specific products involving the FTT, one market research report (Technavio, 2017) predicts that the global smoked fish market will grow at a compound annual rate of almost 8 percent to reach USD 21.07 billion by 2021, with per capita consumption of fish and seafood increasing by 3 times in developing countries such as China and India. This report also indicates that one of the latest trends gaining traction to respond to market demand is the adoption of new techniques for smoking fish, and that manufacturers are developing innovative technologies such as the FTT to improve the quality and taste of smoked fishery products.

Moreover, in these developing fishing nations that produce smoked fish, there is a range of opportunities to tap into for the steady and sustainable expansion of the FTT. These are, *inter alia*:

- rising medium- and high-income class strata of the population;
- more health-conscious and quality-aware consumers;
- smoked and dried fish are often the major if not the only means of access to fishery products for people in remote areas, with limited cold chain facilities and far from major production centres (Ndiaye, Komivi and Diei-Ouadi, 2015). These are also more affordable compared with other animal protein sources;
- strong commitments at global and regional levels (the 2030 SDGs, Malabo Declaration, and Strategic Plan of Action on Food Security in the ASEAN region) to make achieving FSN a priority on the policy agenda (food safety, which is the driver of development of the FTT, is a dimension of this building block);

- environmental and social concerns, trends in greening the value chains, and the food systems approach to the sustainable agriculture development.

These opportunities are engaging and will play an instrumental role in the era of the FTT's widespread dissemination. However, within the SSF perspective, a precautionary approach is needed, as shown by the eight-year long experience of using the FTT. Beyond the financial affordability criterion of any asset, the FTT country case studies have shown that the top three factors by far in influencing the adoption and sustainable use of this technology are: physical access or geographical context (proximity of the kilns *vis-à-vis* processors' dwellings); sociodemographic factors (number of units available/possible turnover); and environmental and sanitary parameters (preservation of processors' health and working conditions). Therefore, these factors must be mainstreamed in the planning, design and installation of the FTT, while paying due regard to the business environment.

Given these observations, it can be concluded that although the FTT fulfils all dimensions of sustainability (economic, environmental, sociocultural and institutional), the main problems documented to date with this innovation lie less in its comparative advantages over traditional processes than in the prevailing business environment in general and non-price differentiation in particular. Therefore, to adequately meet the growing demands from FAO Members for a clean technology to smoke fish, a thorough FTT dissemination strategy is required. This involves a mix of measures to be tailored to specific conditions, but overall, the guidance of interest to policymakers, fisheries planners and any development practitioner or institution can be devised at the levels outlined below.

RECOMMENDATIONS

Policy and regulatory framework

Because the FTT ultimately addresses safe food production, it is important that decision-makers make its mainstreaming in the relevant supply chains a top priority. This is about honouring international and regional commitments to the right for all to adequate food for FSN, and would also trigger a multiplier effect on the earnings of SSF actors, and more particularly on women processors and fishmongers. The evidence base should be built up to inform subsequent interventions – from contemplating the introduction or scaling-up to standard setting and to direct support to fishers and education of consumers.

Policy would need to set clear objectives and pursue a longer-term strategy connected to a widespread dissemination of the FTT consistent with sustainable use of the aquatic resources. It is important to examine the contextual factors that may influence the extent to which the gains derived from the kiln could be realized without compromising the health status of existing fisheries resources. Thus, prior to locally promoting the dissemination and scaling-up of the FTT, countries must have a good understanding of the volume and health status of their fisheries resources and their capacity to produce eco-friendly and responsible aquaculture resources. Under no circumstances should the introduction of this technology foster IUU fishing or drive overcapacity and its array of adverse consequences. Hence, an in-depth assessment of existing resources should always be conducted. Moreover, frozen fish imports should be kept at a level that does not threaten the country's trade balance or inflate its treasury bills. The ministry responsible for fisheries and aquaculture and the national statistics institution should work hand in hand to inform decision-making on new FTT units and issuing accreditation to private investors. Most probably, a viable and thriving aquaculture sector may need to be flourishing in order to pave the way for widespread dissemination of the FTT. In short, collecting statistical data on national fish stocks, with appropriate projections on the probable impact of increased fishing activities

that may be induced by the adoption of the FTT, and investigating the potential for increasing aquaculture outputs to support the sustainable supply of fishery products must be established as a precautionary approach to a viable FTT business case.

In terms of a well-informed framework in standard setting and design and enforcement of food safety regulations, a proper risk-based approach is required. As an illustration, the EAC's specification initiative in smoked fish, smoke-flavoured and smoke-dried fish standards demonstrates a willingness among governments to improve smoked fish safety by including the matter in their harmonized standards. It is significant that PAHs are addressed as one of the food safety priorities, and this should serve as an example to national or other regional economic communities. However, for consistency and effectiveness in food-safety risk management, further development is needed that entails supporting this by risk assessments for PAHs within that region, and then establishing subsequent limits on a similar premise (i.e. informed by a risk assessment in that context) for clearly defined markers. Institutionalization of the technology is also an aspect that warrants due attention, because it bolsters the potential for improved knowledge and institutional sustainability.

On both matters, the risk-based approach and institutional anchoring, the aforementioned examples from Ghana of a nationwide risk assessment of PAHs in smoked fish and mainstreaming the FTT in the curriculum of the University of Ghana should be highlighted for informed decision-making in other countries. The latter was so significant that it is now included as part of the course in animal products processing technology offered by the Department of Nutrition and Food Science.

Setting standards and regulations, and defining benchmarking and traceability schemes for smoked fish, are essential tasks. However, actually meeting the food safety objectives with the FTT at the heart of the smoked fish business would require meeting the challenge of ensuring compliance and deterring any irresponsible practices, such as fraudulently labelling or packaging products as FTT products for sale. A consistent enforcement framework would strengthen or restore consumer confidence and prevent any action that could undermine the fish operators' striving to adopt the technology as a result of a perceived lack of incentives.

Planning, design and extension process

- The location of FTT kilns or their proximity *vis-à-vis* the intended users' home is essential and plays a central role – the closer the FTT kilns to the processors' home, the higher the likelihood that they will adopt them. Thus, this underscores the importance of actively involving processors in the design of FTT adapted to the local context, and their role in terms of their knowledge of local customs and in the choice of location for each kiln. It is a matter of course to recall that the outreach officers or agents engaging with them, given the context of SSF, should have a basic knowledge of community approaches, including participatory rural dialogue and appraisal skills.
- To date, the FTT interventions across the country case studies under review have been funded either entirely by development agencies or jointly with government agencies. Therefore, the challenge is how to make sure that smallholder fish processors can invest in the FTT without external funding. This calls for more stakeholder and community engagement in terms of shared contribution (in cash or in kind through the provision of plots of land, materials, equipment and labour) towards the establishment of FTT units.

Infrastructure and services

- Although there are many different topics that need to be considered in order to improve the market environment and market access for women fish smokers and fishmongers, the three most crucial ones as regards the effective adoption

and dissemination of the FTT are: (i) capacity development; (ii) access to financing and savings instruments; and (iii) infrastructure and services. Hence, the light of the recommendation is herewith specifically cast on them in terms of financial services and public facilities (namely physical markets, market information and roads).

- As stated above, the upfront investment required for a technically compliant FTT may seem beyond the reach of the average smallholder fish processor in SSA and Asia. It is also clear that this trade-off factor should be addressed not only from a financial perspective but more importantly from a broad policy perspective. In fact, more effort needs to be made to improve the enabling environment with a view to promoting investment that fosters tailored microcredit and savings systems. Moreover, social measures and safety nets should be mainstreamed in sector programmes and projects, while deterring the dependency syndrome. By drawing on lessons learned from using certain tools such as warehouse receipts, financing mechanisms should be devised to better manage the gaps between supply and demand in the fisheries and aquaculture sector for different contexts. Because cash is needed for household consumption necessities and for children's school fees, etc., the warehouse receipt systems used in other sectors (for example, the "resi gudang" system in the agriculture sector in Indonesia [Wibowo *et al.*, 2017]) enables their resilience through this cash flow, and secures the benefits of storing well-processed and good-quality fish for long periods, thus leveraging against price fluctuations.

An important relevant framework is that FAO is a member of the CABFIN project, which has designed training courses for financial institutions to be in a position to design alternative financial instruments for agricultural enterprises, which encompass fisheries and aquaculture businesses. The public and banking sectors could promote support and collaboration with CABFIN to improve credit flow and business growth.

In most SSA and Asian countries, roads are the main means of transportation for foodstuffs, whether fresh or processed. The availability of these products on the right market at the right time is highly dependent on road quality and accessibility, and on market inspectorate services. The impact of safety on roads in deterring or enabling physically bringing goods to markets, as evidenced in the Volta Basin riparian countries in West Africa, should be acknowledged at its due level of importance. This is in view of the detrimental effects of insecurity on roads, particularly because of armed robberies and illegal roadblocks, which particularly drive PHL through an artificial glut at producing centres while major markets are poorly supplied. The consequences of the lack of safety are economic losses as well as subsequent trauma, sustained vulnerability and a poverty cycle in which poor women processors and traders are trapped (Diei-Ouadi *et al.*, 2015). Hence, at the national level, commitment is needed to remove illegal and trade roadblocks through a ban spearheaded by the police and other security agencies. It is also important to strengthen requests from the fisheries and aquaculture sector as a whole, from large wholesalers to artisanal fisheries representatives, to dialogue with governments and regional economic communities to take action on dismantling unnecessary checkpoints, including illegal ones.

In terms of marketing channels, FTT products can boast of having at least three opportunities: stringently regulated export markets and regional markets, and, on the domestic side, the supermarket outlets and open markets. It is a common observation that the technical and sanitary conditions of the domestic informal markets are not conducive to safety and quality assurance. Consequently, even for quality products such as FTT smoked fish, these prevailing conditions are not reassuring for better marketing and do not lay any foundation for attracting upper- and middle-class consumers who could pay premium prices. Poor environmental sanitation and waste

management, a deficient cold chain for storage or ice facilities, the lack of potable water, and the high likelihood of cross-contamination (e.g. fishery products being displayed without separation from livestock products [such as eggs] and vegetables [forbidden under GHP rules]) call for proper investment to improve market hygiene conditions, infrastructure and management. Although this is generally the responsibility of policymakers, local government or municipal authorities, it can and should involve private sector actors.

Capacity development and business skills

Capacity development is a cross-cutting issue that is to be embedded in all the different dimensions. Generally, from lessons gleaned from the case studies and from the authors' experience, development assistance to smallholders in fisheries has proved more effective and sustainable within a context of good group dynamics. Similarly, efforts should be geared towards institutional capacity development and awareness raising in terms of economies of scale, rather than primarily echoing the access to the innovative technology, in order to foster its ownership and adoption among users (L.B. Akoun, personal communication, 2018), and the efficient use and management of the FTT. Whether the approach concerns a larger group, cooperative or a cluster of innovation flagbearers, these two options can only work if the recipients are convinced and dedicated to doing business together, and if they strategize responsibly to derive individual benefits from stronger collective gains.

Technical training on the use and management of the FTT should involve adequately skilled persons or institutions. Piecemeal interventions should be avoided as they are not sustainable. Given that most women do not have bookkeeping or cost-benefit analysis skills, training that allows them to define their financial needs for expansion, and manage a bank account and/or a loan should be nailed down in the list of priority interventions. Dedicated market stalls for FTT products that may actually be labelled with their cooperative's logo or name should be set up. This calls for specific accounting and marketing skills (potentially exchanging with fair trade or/and farmers' markets in other parts of the world).

Cooperatives or clusters should be given support to identify domestic professional clients – such as supermarkets, restaurants and hotels, boarding school feeding programmes/facilities and hospitals, residing expatriates and diplomatic missions – and organizing special events with them. The constraint with public procurement, linked to the voucher system or supply of products preceding a relatively long payment timeline, should be carefully assessed for its suitability for small processors, who usually reap their livelihoods from a day-to-day income.

Basic marketing techniques should be encouraged, such as helping processor clusters, groups and cooperatives build a brand, produce business cards or print product labels with marketing information and contacts; this with a view to enhancing visibility and helping drive and stabilizing sales.

Fishmongers of FTT products should be trained in communicating with their clients on the quality of their products (safer, more nutritious, better for the environment – potentially with a reforestation campaign – reduced losses and less waste, longer shelf-life, product quality meeting international safety standards while preserving local flavour, taste and aroma and hot-smoking practices, etc.) and in advocacy for the rationale of pricing of their smoked fish.

Promotion and consumer education for behaviour change

Smoked products from traditional kilns pose public health challenges. However, it is important to avoid communicating such facts in a language that demonizes the products and the hardworking processors (most of whom are women) who, by their activities, provide crucial support for FSN and obtain their livelihoods thereby. Such

communication could cause scaremongering among consumers with direct adverse implications for FSN, PHL reduction, and the livelihoods of smoked fish processors and fishmongers. Therefore, it is important to ensure that advocacy messages on the FTT emphasize the positive note that it is an **improvement** on traditional kilns for the benefit of all stakeholders.

Sensory attributes such as colour, texture, aroma and taste of food products affect their acceptance by consumers. For hot-smoked fish, there appears to be a cultural perception of an association between the colour of the product and its quality: the darker, the better. Hence, this represents a public education task on the relationship between the darkness of the smoked products (in reality, the degree of tar deposit on the fish), the safety of same, and the implications for consumers' health.

It is probable that public education on **both** the health challenges associated with consumption of smoked fish from traditional kilns **and** the protection afforded by the FTT in that regard will contribute to efforts aimed at promoting the adoption and sustained use of this new technology.

Therefore, governments should commit to providing or promoting continuous education of fish processors, consumers and other actors along the smoked fish value chain on:

- the harmful health effects of PAHs;
- the high levels of PAHs in traditionally smoked fish;
- the benefits of consuming fish smoked on improved kilns such as the FTT.

Governments and the private sector (including processor cooperatives) should promote these campaigns hand in hand so that responsibilities are actually shared, with governments safeguarding consumers and encouraging them to make good choices, and the private sector priding itself on providing these high-quality products.

Depending on the national or local context, these campaigns should use the most effective media and ICT supports, which may include:

- radio shows;
- news programmes on television;
- videos shown on television programmes;
- mobile phone information flashes;
- posters;
- information booth at the entrance of markets;
- kakemonos;
- special events co-sponsored by the fisheries authorities and cooperatives.

Similarly, in order to foster a culture of excellence and to reward operators enforcing best practices, a study should be conducted on good practices regarding access to market information by producers in different food value chains in order to inform guidelines for fisheries interest groups, state services and chambers of commerce.

Participation in local, national and regional trade fairs can provide opportunities to present high-quality products while also giving processors the chance to see what others are producing and to create sales with potential customers.

Fisheries ministries should have a marketing division that can provide capacity development at provincial and district level, especially for extension workers. Market information should also be made available through the different communication tools, including ICT used by fishers, processors and fishmongers (mobile phone, radio, etc.).

In a nutshell, the FTT is a technology driven by a pressing need from FAO Members, initially to meet export market requirements. However, their commitments to realizing food security objectives for all and the opportunities for greater post-harvest benefits domestically and regionally make the FTT the best tool. The authors hope that this review of the FTT's eight years of existence will help FAO Members to discern its main attributes and how it may contribute to more sustainable fisheries practices by safeguarding consumers and processors' health, reducing PHFLs and answering global

market needs. However, it is necessary to be aware that the FTT *per se* is neither the panacea for all situations, nor a one-size-fits-all tool that can be designed, constructed, disseminated or managed on a sustainable basis without the depicted enabling dimensions, most of which – from an SSF perspective – require specific attention from policymakers, fisheries planners and development practitioner institutions.

References

- Abban, E.K., Asmah, R., Awity, L. & Ofori, J.K. 2009. *Review on national policies and programmes on aquaculture in Ghana* [online]. [Cited 21 September 2018]. www.ruaf.org/sites/default/files/Ghana%20Aquaculture%20Policy%20review%20final_1.pdf
- Abidjan.net. 2017. Pêche: Inauguration du débarcadère MOHAMMED VI de Locodjro. In: *Abidjan.net* [online]. [Cited 21 September 2018]. <https://news.abidjan.net/h/626626.html>
- African Union Commission (AUC). 2014. *Malabo Declaration on Accelerated Agricultural Growth and Transformation for Shared Prosperity and Improved Livelihoods* [online]. [Cited 17 September 2018]. www.resakss.org/sites/default/files/Malabo%20Declaration%20on%20Agriculture_2014_11%2026-.pdf
- African Union Commission (AUC) & NEPAD Agency. 2014. *Policy Framework and Reform Strategy for Fisheries and Aquaculture in Africa: Creating a conducive and enabling environment for the fish sector to create equitable, social and economic development in Africa* [online]. [Cited 21 September 2018]. https://au.int/sites/default/files/documents/30266-doc-au-ibar_-_fisheries_policy_framework_and_reform_strategy.pdf
- Akoun, M.L.B. 2018. Rapport technique mission de différenciation et commercialisation des produits FTT au Burkina Faso. FAO. Unpublished.
- Anoh, K.P., Ouattara, S. & Ossey, Y.P. 2016. *Santé des femmes transformatrices, sécurité sanitaire des produits et impact environnemental des systèmes de fumage de poisson dans les communautés de pêche artisanale, étude pour des systèmes alimentaires durables, IGT/FAO, Projet n° 009-2015/2015/ IGT-GCP/RAF/488/NOR*. 77 pp.
- Anoh, K.P., Ouattara, S., Ossey, Y.B., Dembélé, A.A. & Traoré, K.S. 2018. Santé des femmes transformatrices, sécurité sanitaire des produits et impact environnemental des systèmes de fumage de poisson dans les communautés de pêche artisanale – Étude pour des systèmes alimentaires durables. In FAO. *Report and papers presented at the fourth Meeting of Professionals/Experts in support of Fish Safety, Technology, and Marketing in Africa, Elmina, Ghana, 14–16 November 2017. Rapport et documents présentés à la quatrième réunion des professionnels/experts en appui à la sécurité sanitaire, à la technologie et au commerce du poisson en Afrique, Elmina, Ghana, 14-16 novembre 2017*, pp. 131–144. FAO Fisheries and Aquaculture Report / FAO Rapport sur les pêches et l'aquaculture No. 1228. Rome, FAO. 355 pp. (also available at www.fao.org/3/ca0374b/CA0374B.pdf).
- Anon. 2011. *Resolution on Sustainable Fisheries for Food Security for the ASEAN Region Towards 2020* [online]. [Cited 21 September 2018]. www.asean.org/storage/images/archive/AMAF%2033%20Resolution%20Sustainable%20Fisheries_Adopted.pdf
- Anon. 2014. *Report on tailor-made training for fisheries practitioners from the Republic of Angola. Fisheries Education and Training Agency (FETA)*. 26 pp.
- Antwi, H. & Beran, K. 2018. Implementing post-harvest value chain improvements in small-scale fisheries in Elmina, Ghana. In FAO. *Report and papers presented at the fourth Meeting of Professionals/Experts in support of Fish Safety, Technology, and Marketing in Africa, Elmina, Ghana, 14–16 November 2017. Rapport et documents présentés à la quatrième réunion des professionnels/experts en appui à la sécurité sanitaire, à la technologie et au commerce du poisson en Afrique, Elmina, Ghana, 14-16 novembre 2017*, pp. 118–130. FAO Fisheries and Aquaculture Report / FAO Rapport sur les pêches et l'aquaculture No. 1228. Rome, FAO. 355 pp. (also available at www.fao.org/3/ca0374b/CA0374B.pdf).

- Association of Southeast Asian Nations (ASEAN). undated. *ASEAN Integrated Food Security (AIFS) Framework and Strategic Plan of Action on Food Security in the ASEAN Region (SPA-FS) 2015-2020* [online]. [Cited 21 September 2018]. www.asean-agrifood.org/?wpfb_dl=58
- Atikpo, M.O., Nkansah, J., Avega, B. & Kwarteng, E. 2018. Introduction of simplified grading system for the production of hygienic smoked fish by processors for Ghanaian premium markets. In FAO. *Report and papers presented at the fourth Meeting of Professionals/Experts in support of Fish Safety, Technology, and Marketing in Africa, Elmina, Ghana, 14-16 November 2017. Rapport et documents présentés à la quatrième réunion des professionnels/experts en appui à la sécurité sanitaire, à la technologie et au commerce du poisson en Afrique, Elmina, Ghana, 14-16 novembre 2017*, pp. 154-163. FAO Fisheries and Aquaculture Report / FAO Rapport sur les pêches et l'aquaculture No. 1228. Rome, FAO. 355 pp. (also available at www.fao.org/3/ca0374b/CA0374B.pdf).
- Barka, H.B. 2012. *Border posts, checkpoints, and intra African trade: challenges and solutions, publications of African Development Bank (AFDB)*. [Cited 20 June 2018]. [Cited 21 September 2018]. www.afdb.org/fileadmin/uploads/afdb/Documents/Publications/INTRA%20AFRICAN%20TRADE_INTRA%20AFRICAN%20TRADE.pdf
- Ben-Yami, M. & Anderson, A.M. 1985. *Community fishery centres: guidelines for establishment and operation*. FAO Fisheries Technical Paper No. 264. Rome, FAO. 94 pp. (also available at www.fao.org/docrep/003/X6863E/X6863E00.HTM).
- Bjorndal, T., Child, A. & Lem, A., eds. 2014. *Value chain dynamics and the small-scale sector: policy recommendations for small-scale fisheries and aquaculture trade*. FAO Fisheries and Aquaculture Technical Paper No. 581. Rome, FAO. 112 pp. (also available at www.fao.org/3/a-i3630e.pdf).
- Blay, D. & Atikpo, M.O. 2007. Design and construction of AFSMO – 150, an improved fish smoking oven. In FAO. *Report and papers presented at the FAO Workshop on Fish Technology, Utilization and Quality Assurance. Bagamoyo, United Republic of Tanzania, 14-18 November 2005. Rapport et documents présentés à l'Atelier de la FAO sur la technologie, l'utilisation et l'assurance de qualité du poisson. Bagamoyo, République-Unie de Tanzanie, 14-18 novembre 2005*, pp. 49-56. FAO Fisheries Report / FAO Rapport sur les pêches No. 819. Rome, FAO. 262 pp. (also available at www.fao.org/3/a-a1117b.pdf).
- Bølling, A.K., Pagels, J., Yttri, K.E., Barregard, L., Sallsten, G., Schwarze, P.E. & Boman, C. 2009. Health effects of residential wood smoke particles: the importance of combustion conditions and physicochemical particle properties. *Particle and Fibre Toxicology*, 6: 29 [online]. [Cited 21 September 2018]. <https://doi.org/10.1186/1743-8977-6-29>
- Bomfeh, K. 2016. *Meeting food safety targets in shifting from traditional to new fish smoking systems: a case study in Ghana. A Food Safety Technical Network (FSTN) webinar/seminar – 16 September 2016* [slideshow]. FAO / University of Ghana / Ghent University. [Cited 18 September 2018]. <http://fr.slideshare.net/FAOoftheUN/meeting-food-safety-targets-in-shifting-from-traditional-to-new-fish-smoking-systems-study-in-ghana>
- Bomfeh, K., De Meulenaer, B., Jacxsens, L., Amoa-Awua, W.K., Tandoh, I. & Afoakwa, E.O. 2016. *Meeting food safety targets in shifting from traditional to new fish smoking systems: a case study in Ghana. A collaborative study by the Food and Agriculture Organization, University of Ghana and Ghent University*. Final report.
- Bomfeh, K., De Meulenaer, B., Jacxsens, L., Amoa-Awua, W.K., Tandoh I., Afoakwa, E.O., Diei-Ouadi, Y. & Garrido Gamarro, E. 2018. Improving the safety of smoked fish through kiln design: the case of FAO-Thiaroye technique in Ghana. In FAO. *Report and papers presented at the fourth Meeting of Professionals/Experts in support of Fish Safety, Technology, and Marketing in Africa, Elmina, Ghana, 14-16 November 2017. Rapport et documents présentés à la quatrième réunion des professionnels/experts en appui à la*

- sécurité sanitaire, à la technologie et au commerce du poisson en Afrique, Elmina, Ghana, 14-16 novembre 2017, pp. 164–174. FAO Fisheries and Aquaculture Report / FAO Rapport sur les pêches et l'aquaculture No. 1228. Rome, FAO. 355 pp. (also available at www.fao.org/3/ca0374b/CA0374B.pdf).
- Botha, N. & Atkins, K.** 2005. *An assessment of five different theoretical frameworks to study the uptake of innovations*. Paper presented at the 2005 NZARES Conference, Tahuna Conference Centre – Nelson, New Zealand. 26-27 August 2005. New Zealand Agricultural and Resources Economics Society. (available at <https://ageconsearch.umn.edu/bitstream/98497/2/2005-5-assessment%20of%20five%20different%20theoretical%20frameworks%20to%20study%20the%20uptake%20of%20innovations.pdf>).
- Bungubetshi, G., Hambadihana, C., Biyetidi, J., Isekama, A. & Nkuku, J.** 2018. Évaluation de l'adoption du four Chorkor en République Démocratique du Congo. In FAO. *Report and papers presented at the fourth Meeting of Professionals/Experts in support of Fish Safety, Technology, and Marketing in Africa, Elmina, Ghana, 14–16 November 2017. Rapport et documents présentés à la quatrième réunion des professionnels/experts en appui à la sécurité sanitaire, à la technologie et au commerce du poisson en Afrique, Elmina, Ghana, 14–16 novembre 2017*, pp. 251–264. FAO Fisheries and Aquaculture Report / FAO Rapport sur les pêches et l'aquaculture No. 1228. Rome, FAO. 355 pp. (also available at www.fao.org/3/ca0374b/CA0374B.pdf).
- Burrows, M.** 2012. *Global Trends 2030: Alternative worlds (2012)* [online]. National Intelligence Council [Cited 21 September 2018]. www.dni.gov/nic/globaltrends.
- BusinessWire.** undated. *Top 3 emerging trends impacting the global fish market from 2017-2021: Technavio* [online]. [Cited 21 September 2018]. www.businesswire.com/news/home/20170421005366/en/Top-3-Emerging-Trends-Impacting-Global-Smoked
- Chabi, N.W., Konfo, C.T.R., Emonde, P.D.M., Chichi, M.T.C., Sika, K.J.K.C., Alamou, Y., Keke, M., Dahouenon-Ahoussi, E. & Baba-Moussa, L.S.** 2014. Performance d'un dispositif amélioré de fumage (four Chorkor) sur la qualité du poisson fumé dans la commune d'Aplahoué (Sud-est du Bénin). *International Journal of Innovation and Applied Studies*, 9(3): 1383–1391 [online]. [Cited 21 September 2018]. www.issr-journals.org/links/papers.php?journal=ijias&application=pdf&article=IJIAS-14-264-06
- Cham, F.B.** 2018. FAO hands-over D1.9M fish smoking oven to Gunjur community [online]. *The Point Newspaper*, Banjul, The Gambia. [Cited 21 September 2018]. <http://thepoint.gm/africa/gambia/article/fao-hands-over-d19m-fish-smoking-oven-to-gunjur-community>).
- Codex Alimentarius Commission (CAC).** 2003. Code of Practice for Fish and Fishery Products. CAC/RCP 52-2003.
- Codex Alimentarius Commission (CAC).** 2009. *CAC/RCP 68-2009, Code of Practice for the Reduction of Contamination of Food with Polycyclic Aromatic Hydrocarbons (PAH) from Smoking and Direct Drying Processes*. (also available www.fao.org/input/download/standards/11257/CXP_068e.pdf).
- Codex Alimentarius Commission (CAC).** 2013. *Standard for smoked fish, smoke-flavoured fish and smoke-dried fish. CODEX STAN 311–2013*.
- Côte d'Ivoire.** 2014. *Plan Stratégique de Développement de l'Élevage, de la Pêche et de l'Aquaculture en Côte d'Ivoire (PSDEPA-CI, 2014–2020)* [online]. [Cited 21 September 2018]. <http://extwprlegs1.fao.org/docs/pdf/ivc146471.pdf>
- Côte d'Ivoire.** 2016. *Loi n° 2016-554 du 26 juillet 2016 relative à la pêche et à l'aquaculture* [online]. [Cited 21 September 2018]. <http://extwprlegs1.fao.org/docs/pdf/ivc159952.pdf>
- Côte d'Ivoire.** undated a. *Plan Directeur des Pêches et de l'Aquaculture 2010 – 2025* [online]. [Cited 21 September 2018]. <http://lists.stir.ac.uk/pipermail/sarnissa-french-aquaculture/attachments/20090605/a7f2d5d3/attachment-0006.doc>

- Côte d'Ivoire.** undated b. *Plan Directeur des Pêches et de l'Aquaculture (PDPA – 2010-2025)* [online]. [Cited 21 September 2018]. <http://lists.stir.ac.uk/pipermail/sarnissa-french-aquaculture/attachments/20090605/a7f2d5d3/attachment-0007.doc>
- Daily FT.** 2017. An innovation in fish-smoking improves lives. In: *Daily FT* [online]. [Cited 21 September 2018]. www.ft.lk/agriculture/An-innovation-in-fish-smoking-improves-lives/31-644717
- Deloitte & Touche.** 2015. *Reducing food loss along African agricultural value chains* [online]. [Cited 21 September 2018]. www2.deloitte.com/content/dam/Deloitte/za/Documents/consumer-business/ZA_FL1_ReducingFoodLossAlongAfricanAgriculturalValueChains.pdf
- de Graaf, G. & Garibaldi, L.** 2014. *The value of African fisheries*. FAO Fisheries and Aquaculture Circular No. 1093. Rome, FAO. 76 pp. (also available at www.fao.org/3/a-i3917e.pdf).
- Diei-Ouadi, Y. & Mgawe, I.** 2011. *Post-harvest fish loss assessment in small-scale fisheries: A guide for the extension officer*. FAO Fisheries and Aquaculture Technical Paper No. 559. Rome, FAO. 93 pp. (also available at www.fao.org/docrep/014/i2241e/i2241e.pdf).
- Diei-Ouadi, Y. & Sodoke, K.** 2013. The FAO-Thiaroye fish processing technique - an innovation in small-scale fisheries. An innovative fish processing technique has proved capable of controlling polycyclic aromatic hydrocarbons produced in fish smoking and drying. In: *Highlights of INFOFISH International* No. 1/ 2013.
- Diei-Ouadi, Y., Randrianantoandro, A. & Ndiaye, O.** 2017. Inclusiveness and efficiency in post-harvest loss reduction – a glance at the FAO-Thiaroye fish processing technology. In: *The 1st All Africa Post Harvest Congress & Exhibition. Reducing Food Losses and Waste: Sustainable Solutions for Africa. Conference Proceedings* [online]. Nairobi. [Cited 21 September 2018]. [http://plantscience.uonbi.ac.ke/sites/default/files/cavs/agriculture/plantscience/Congress%20Proceedings%20\(Peer-reviewed%20Extended%20Abstracts\)2.pdf](http://plantscience.uonbi.ac.ke/sites/default/files/cavs/agriculture/plantscience/Congress%20Proceedings%20(Peer-reviewed%20Extended%20Abstracts)2.pdf)
- Diei-Ouadi, Y., Sodoke, Komivi, B., Oduro, F.A., Ouedraogo, Y., Bokobosso, K. & Rosenthal, I.** 2015. *Strengthening the performance of post-harvest systems and regional trade in small-scale fisheries: case study of post-harvest loss reduction in the Volta Basin riparian countries*. FAO Fisheries and Aquaculture Circular No. 1105. Rome, FAO. (also available at www.fao.org/3/a-i5141e.pdf).
- Dienye, P., Akani, A. & Okokon, I.** 2016. Respiratory effects of biomass fuel combustion on rural fish smokers in a Nigerian fishing settlement: a case control study. In: *African Health Sciences*, 16(2): 516–23. (also available at <https://www.ajol.info/index.php/ahs/article/view/138612>).
- Diomandé, L.J.** undated. *Réduction des pertes post-capture des produits halieutiques (PCT/IVC/3501)* [slideshow]. PowerPoint Document. 28 slides. [Cited 21 September 2018]. www.fao.org/fileadmin/user_upload/food-loss-reduction/C%20C3%B4te_d_Ivoire_presentation_Douala_June_2016.pdf
- Diomandé, L.J., Holvoet, K. & Coulibaly, D.** 2018. Stratégie durable de mise à niveau de la chaîne de valeur poisson inclusive des aspects genre et mise en œuvre d'interventions d'autonomisation des femmes dans le secteur de la pêche artisanale. In FAO. *Report and papers presented at the fourth Meeting of Professionals/Experts in support of Fish Safety, Technology, and Marketing in Africa, Elmina, Ghana, 14–16 November 2017. Rapport et documents présentés à la quatrième réunion des professionnels/experts en appui à la sécurité sanitaire, à la technologie et au commerce du poisson en Afrique, Elmina, Ghana, 14-16 novembre 2017*, pp. 229–237. FAO Fisheries and Aquaculture Report / FAO Rapport sur les pêches et l'aquaculture No. 1228. Rome, FAO. 355 pp. (also available at www.fao.org/3/ca0374b/CA0374B.pdf).

- Djessouho, C. 2018. Sécurité sanitaire et commercialisation des produits de pêche fumés à chaud et séchés en Afrique et en Asie. In FAO. *Report and papers presented at the fourth Meeting of Professionals/Experts in support of Fish Safety, Technology, and Marketing in Africa, Elmina, Ghana, 14–16 November 2017. Rapport et documents présentés à la quatrième réunion des professionnels/experts en appui à la sécurité sanitaire, à la technologie et au commerce du poisson en Afrique, Elmina, Ghana, 14-16 novembre 2017*, pp. 294–307. FAO Fisheries and Aquaculture Report / FAO Rapport sur les pêches et l'aquaculture No. 1228. Rome, FAO. 355 pp. (also available at www.fao.org/3/ca0374b/CA0374B.pdf).
- EastJava.com. 2010. Ready to eat smoked fish. In: *EastJava.com* [online]. [Cited 21 September 2018]. <https://eastjava.com/blog/2010/11/15/ready-to-eat-smoked-fish/>
- Ekomy, A.S. 2008. Vulgarisation d'un nouveau concept amélioré de séchage et de fumage artisanal des aliments : Application en milieu pêche artisanale au Gabon. In FAO. *Report and papers presented at the second workshop on fish technology, utilization and quality assurance in Africa*. FAO Fisheries and Aquaculture Report No. 904. Rome, FAO. 201 pp. (also available at www.gbv.de/dms/sub-hamburg/608705691.pdf).
- European Food Safety Authority (EFSA). 2008. Scientific Opinion of the Panel on Contaminants in the Food Chain on a request from the European Commission on Polycyclic Aromatic Hydrocarbons in Food. *The EFSA Journal*, 724: 1–114.
- European Union. 2011. *Commission Regulation (EU) No 835/2011 of 19 August 2011 amending Regulation (EC) No 1881/2006 as regards maximum levels for polycyclic aromatic hydrocarbons in foodstuffs*. [online]. [Cited 21 September 2018]. available at www.fsai.ie/uploadedFiles/Reg835_2011.pdf
- FAO. 1995. *Code of Conduct for Responsible Fisheries*. Rome. 41 pp. (also available at www.fao.org/3/a-v9878e.pdf).
- FAO. 2003. *EAF guidelines: Fisheries management 2. The ecosystem approach to fisheries*. FAO Technical Guidelines for Responsible Fisheries No. 4, Suppl. 2. Rome. 112 pp. (also available at www.fao.org/3/a-y4470e.pdf).
- FAO. 2005. *Simplified version of EAF guidelines: Putting into practice the ecosystem approach to fisheries*. Rome. 76 pp. (also available at www.fao.org/docrep/009/a0191e/a0191e00.htm)
- FAO. 2007. *Report and papers presented at the FAO Workshop on Fish Technology, Utilization and Quality Assurance. Bagamoyo, United Republic of Tanzania, 14–18 November 2005*. FAO Fisheries Report No. 819. Rome. 262 pp. (also available at www.fao.org/3/a-a1117b.pdf).
- FAO. 2009a. *Report and papers presented at the second Workshop on Fish Technology, Utilization and Quality Assurance in Africa. Agadir, Morocco, 24–28 November 2008*. FAO Fisheries and Aquaculture Report No. 904. Rome. 201 pp. (also available at www.gbv.de/dms/sub-hamburg/608705691.pdf).
- FAO. 2009b. *The human dimensions of EAF: Fisheries management. 2. The ecosystem approach to fisheries. 2.2 Human dimensions of the ecosystem approach to fisheries*. FAO Technical Guidelines for Responsible Fisheries No. 4, Suppl. 2, Add. 2. Rome. 88 pp. (also available at www.fao.org/3/a-i1146e.pdf)
- FAO. 2011. *Global food losses and food waste – Extent, causes and prevention*. Rome. (also available at www.fao.org/docrep/014/mb060e/mb060e.pdf).
- FAO. 2011–2017. *Interactive online version of EAF Toolbox: EAF-Net. EAF Toolbox* [online]. Rome. [Cited 21 September 2018]. www.fao.org/fishery/eaf-net/toolbox/en
- FAO. 2012a. *The State of World Fisheries and Aquaculture 2012*. Rome. 209 pp. (also available online at www.fao.org/3/a-i2727e.pdf).
- FAO. 2012b. *Report and papers presented at the third Workshop on Fish Technology, Utilization and Quality Assurance in Africa. Victoria, Mahe, Seychelles, 22–25 November 2011*. FAO Fisheries and Aquaculture Report No. 990. Rome, FAO. 263 pp. (also available at www.fao.org/docrep/017/i3093b/i3093b.pdf).

- FAO. 2012c. *EAF Toolbox: EAF Toolbox: the ecosystem approach to fisheries*. Rome.
- FAO. 2012d. *Voluntary Guidelines on the Responsible Governance of Tenure of Land, Fisheries and Forests in the Context of National Food Security*. 40 pp. (also available at www.fao.org/docrep/016/i2801e/i2801e.pdf).
- FAO. 2012e. *Gender mainstreaming in small-scale fisheries. Lessons learned notes. Regional Fisheries Livelihoods Programme for South and Southeast Asia (RFLP)*. 9 pp. (also available at www.fao.org/3/a-ar469e.pdf).
- FAO. 2013a. *Regional Fisheries Livelihood Programme for South and Southeast Asia (RFLP). Improved quality of fishery products and market chains. Food and Agriculture Organization of the United Nations* [online]. [Cited 21 September 2018]. www.fao.org/3/a-ar467e.pdf
- FAO. 2013b. *Mainstreaming gender in fisheries and aquaculture: a stock-taking and planning exercise*. Final report. Rome. 55 pp. (also available at www.fao.org/3/a-i3184e.pdf).
- FAO. 2014. *Improving diets and nutrition food-based approaches*, edited by B. Thompson & L. Amoroso. Rome. (also available at www.fao.org/3/a-i3030e.pdf).
- FAO. 2015a. *Voluntary Guidelines for Securing Sustainable Small-Scale Fisheries in the Context of Food Security and Poverty Eradication*. 18 pp. (also available online at www.fao.org/3/i4356en/I4356EN.pdf).
- FAO. 2015b. *Building veterinary laboratory diagnostic capacity in Africa: the VETLAB Network*. FCC-EMPRES Information Sheet 6. Rome. (also available at www.fao.org/3/a-i4728e.pdf).
- FAO. 2015c. *Strengthening regional veterinary laboratory networks in Africa and Asia*. FCC-EMPRES Information Sheet 10. Rome. (also available at www.fao.org/3/a-bb010e.pdf).
- FAO. 2016a. *The State of World Fisheries and Aquaculture 2016. Contributing to food security and nutrition for all*. Rome. 200 pp. (also available online at www.fao.org/3/a-i5555e.pdf).
- FAO. 2016b. *Appui à filière de la pêche artisanale continentale : vulgarisation des techniques post-capture au nord-ouest de l'Angola*. TCP/ANG/3403. Rapport terminal pour le Gouvernement de l'Angola.
- FAO. 2016c. *A Strategy for sustainable fisheries and aquaculture in the Volta Basin riparian countries' post-harvest chains and regional trade*. FAO Fisheries and Aquaculture Circular No. 1121. Rome. (also available at www.fao.org/3/a-i5935e.pdf).
- FAO. 2016d. *FTT-Thiaroye Ovens in Côte d'Ivoire: transforming lives through simple technology* [video]. [Cited 21 September 2018]. www.youtube.com/watch?v=ejoa524ls4A
- FAO. 2016e. *Equatorial Guinea and FAO: Improving agricultural production, marketing and credit to improve food and nutrition security* [online]. [Cited 21 September 2018]. www.fao.org/3/a-az481e.pdf
- FAO. 2016f. *Appui à la valorisation et à la gestion durable des produits de la pêche artisanale. Guinée-Bissau. Compte rendu final du projet Programme de coopération technique*. FI: TCP/GBS/3401. 9 pp.
- FAO. 2016g. *Pour une politique globale de gestion du secteur de la pêche au Sénégal*. In: *FAO* [online]. [Cited 21 September 2018]. www.fao.org/senegal/actualites/detail-events/fr/c/414466/
- FAO. 2016h. *Developing gender-sensitive value chains – A guiding framework*. Rome. (also available at www.fao.org/3/a-i6462e.pdf).
- FAO. 2017a. *Fishery and Aquaculture Statistics. Global Fisheries commodities production and trade 1976–2015 (Fishstat)*. In: *FAO Fisheries and Aquaculture Department* [online]. Rome. [Cited 21 September 2018]. www.fao.org/fishery/statistics/software/fishstat/en

- FAO. 2017b. *Social sustainability in fisheries value chains and the link to fish trade*. Committee on Fisheries, Sub-Committee on Fish Trade, Busan, Republic of Korea, 4–8 September 2017. COFI:FT/XVI/2017/5. 9 pp. (also available at www.fao.org/fi-static-media/MeetingDocuments/COFI_FT/COFI_FT16/5e.pdf).
- FAO. 2017c. *FAO yearbook. Fishery and Aquaculture Statistics. 2015/FAO annuaire. Statistiques des pêches et de l'aquaculture. 2015/FAO anuario. Estadísticas de pesca y acuicultura. 2015*. Rome/Roma. (also available at www.fao.org/3/a-i7989t.pdf)
- FAO. 2017d. Increasing food production without damaging the environment. In: *FAO* [online]. [Cited 21 September 2018]. www.fao.org/news/story/en/item/889671/icode/
- FAO. 2017e. *Trip for exchange experience of Ghanian fish operators in Abidjan, Cote d'Ivoire* [Cited 21 September 2018]. www.youtube.com/watch?v=PH1lIpUImHs
- FAO. 2018a. *The State of the World Fisheries and Aquaculture 2018 – Meeting the Sustainable Development Goals*. Rome. 210 pp. (also available at www.fao.org/3/I9540EN/i9540en.pdf).
- FAO. 2018b. Food loss and food waste. In: *FAO* [online]. [Cited 21 September 2018]. www.fao.org/food-loss-and-food-waste/en/
- FAO. 2018c. *Gender and food loss in sustainable food value chains – A guiding note*. Rome. 42 pp. (also available online at www.fao.org/3/I8620EN/i8620en.pdf).
- FAO. 2018d. Agroecology can help change the world's food production for the better. In: *FAO* [online]. [Cited 21 September 2018]. www.fao.org/news/story/en/item/1113475/icode/
- FAO. 2018e. *Différentiation et commercialisation des poissons fumés FTT* [online]. Projet FMM/GLO/103/MUL. [Cited 21 September 2018]. www.fao.org/3/i8875fr/I8875FR.pdf
- FAO. 2018f. Equatorial Guinea. In: *FAO* [online]. [Cited 21 September 2018]. www.fao.org/countryprofiles/index/en/?iso3=GNQ
- FAO. 2018g. De hornos tradicionales a modernos para la mejora de técnicas de conservación y transformación de la pesca artesanal nacional. In: *FAO* [online]. [Cited 21 September 2018]. www.fao.org/guinea-ecuatorial/noticias/detail-events/es/c/1103640/
- FAO. 2018h. Major ongoing projects. In: *FAO* [online]. [Cited 21 September 2018]. www.fao.org/asiapacific/programmes-and-projects/projects/en/
- FAO. undated. *FAO's Input to the UN Secretary-General's Comprehensive Report for the 2016 Resumed Review Conference on the UN Fish Stocks Agreement* [online]. [Cited 21 September 2018]. www.un.org/Depts/los/2016_FAO_Overview.pdf.
- FAO & International Labour Organization (ILO). 2013. *Guidance on addressing child labour in fisheries and aquaculture*. 85 pp. (also available at www.fao.org/docrep/018/i3318e/i3318e.pdf).
- Gana, M.L. & Sule, M.A. 2015. Multiple Checkpoints; a Band of the Free Movement Protocol of Economic of Community of West African States. *International Journal of Innovative Research and Development*, 4(8) [online]. [Cited 21 September 2018]. <http://ijird.com/index.php/ijird/article/view/75320>
- Gebrezgabher, S.A., Amewu, S. & Amoah, P. 2015. Consumer preference and willingness to pay for fish farmed in treated wastewater in Ghana. In: *Selected paper prepared for presentation at the 2015 AAEA and WAEA Joint Annual Meeting, July 26-28, 2015, San Francisco, California*.
- Global Panel. 2017. *Policy actions to support enhanced consumer behaviour for high-quality diets*. Policy Brief No. 8. London.
- Global Sustainable Seafood Initiative (GSSI). 2018. The Global Benchmarking Tool. In: *GSSI* [online]. [Cited 21 September]. www.ourgssi.org/benchmarking/the-global-benchmark-tool/
- Gordon, A., Pulis, A. & Owusu-Adjei, E. 2011. *Smoked marine fish from Western Region, Ghana: a value chain assessment*. USAID Integrated Coastal and Fisheries Governance Initiative for the Western Region, Ghana. WorldFish Center. 46 pp.

- Herbel, D., Crowley, E., Ourabah Haddad, N. & Lee, M.** 2012. *Good practices in building innovative rural institutions to increase food security*. Rome, FAO & IFAD. 117 pp. (also available at www.fao.org/docrep/015/i2258e/i2258e00.pdf)
- Holvoet, K.** 2016. *Analyse des chaînes de valeur sensible au genre sur les 4 sites bénéficiaires du projet TCP/IVC/3501*. Rome, FAO.
- International Collective in Support of Fishworkers.** 2002. *Report of the study on problems and prospects of artisanal fish trade in West Africa*. Chennai, India, International Collective in Support of Fishworkers.
- Joint FAO/WHO Expert Committee on Food Additives (JECFA).** 2006. *Evaluation of certain food contaminants: sixty-fourth report of the Joint FAO/WHO Expert Committee on Food Additives*. WHO Technical Report Series 930. Geneva, WHO. 78 pp. (also available at http://apps.who.int/iris/bitstream/handle/10665/43258/WHO_TRS_930_eng.pdf?sequence=1)
- Joy Online.** 2014. *New fish processing technology launched* [online]. [Cited 21 September 2018]. www.myjoyonline.com/business/2014/December-11th/new-fish-processing-technology-launched.php
- Junianingsih, I., Hakim, L. & Harahab, N.** 2014. Local Wisdom of Smoked Fish Processing as Tourism Product in Situbondo Regency. *Journal of Indonesian Tourism and Development Studies*, 2(3) [online]. [Cited 21 September 2018]. <https://media.neliti.com/media/publications/29347-EN-local-wisdom-of-smoked-fish-processing-as-tourism-product-in-situbondo-regency.pdf>
- Kamal, M.M.** 2006. IT innovation adoption in the government sector: identifying the critical success factors. *Journal of Enterprise Information Management*, 19(2): 192–222. (also available at <http://dx.doi.org/10.1108/17410390610645085>).
- Kazeem, Y.** 2017. More than half the world's population growth will be in Africa by 2050. In: *Quartz Africa* [online]. [Cited 21 September 2018]. <https://qz.com/1016790/more-than-half-of-the-worlds-population-growth-will-be-in-africa-by-2050/>
- Kim, K.H., Jahan S.A., Kabir, E. & Brown R.J.** 2013. A review of airborne polycyclic aromatic hydrocarbons (PAHs) and their human health effects. *Environment International*, 60: 71–80. (also available at <https://doi.org/10.1016/j.envint.2013.07.019>).
- King, D. & Salagrama, V.** (undated). *Introduction of an improved fish smoking method in Andhra Pradesh, India* [online]. Post-Harvest Fisheries Project Department for International Development Information Bulletin 14. Chennai, India. [Cited 21 September 2018]. <http://vikaspedia.in/agriculture/fisheries/smoking-fish>
- Kissai, G. & Mgawe, Y.** 2017. *Field results with regard to strength and weaknesses of using FTT-Thiaroye oven in Tanzania* [online]. [Cited 21 September 2018]. <http://anfts.org/new/wp-content/uploads/2017/09/FETA-THIAROYE-REPORT.pdf>
- Konate, L., Kone, S. & Ouedraogo, Y.** 2017. *Évaluation et analyse de la chaîne de valeur poisson sensible au genre*. Rapport d'étude du projet ASDI Permettre aux femmes de bénéficier de façon plus égale des chaînes de valeur agro-alimentaires. FAO.
- Kusumastanto, T.** 2004. The challenge of improving fish consumption in developing country: the case study of Indonesia. In: *IIFET 2004 Japan Proceedings* [online]. [Cited 21 September 2018]. <http://oregonstate.edu/dept/IIFET/Japan/proceedupdates/papers.html>
- Leral Net.** 2016. Nouvelle Lettre de Politique Sectorielle de Développement des Pêche et de l'Aquaculture : La sécurité alimentaire et nutritionnelle des populations au cœur des débats. In: *Leral Net* [online]. [Cited 21 September 2018]. www.leral.net/Nouvelle-Lettre-de-Politique-Sectorielle-de-Developpement-des-Peche-et-de-l-Aquaculture-La-securite-alimentaire-et_a171690.html
- Lucy, A.** 2016. Vietnam you have my heart. In: *Andrea Lucy* [online]. [Cited 21 September 2018]. <http://foodphotographerireland.com/vietnam-you-have-my-heart/>

- Mafusire, A., Brixiova, Z., Anyanwu, J. & Meng, Q.** 2010. Infrastructure deficit and opportunities in Africa. *Economic Brief*, 1(Sept.) [online]. [Cited 21 September 2018]. www.afdb.org/fileadmin/uploads/afdb/Documents/Publications/ECON%20Brief_Infrastructure%20Deficit%20and%20Opportunities%20in%20Africa_Vol%201%20Issue%202.pdf
- Mambo-Gnakalé, O.** 2015. *Fumage, sécurité et santé au travail : résultat préliminaire d'étude d'une communauté de pêche artisanale*. Université Félix Houphouët-Boigny Cocody-Abidjan. 85 pp. (Mémoire Master).
- Metrowatch.** 2015. Expert warns Nigerians against eating locally-smoked fish. In: *Metrowatchonline.com* [online]. [Cited 21 September 2018]. <http://metrowatchonline.com/expert-warns-nigerians-against-eating-locally-smoked-fish/>
- Mindjimba, K.** 2017a. *Étude de la rentabilité du fumage du poisson avec les fours FTT-Thiaroye en Côte d'Ivoire*. FAO.
- Mindjimba, K.** 2017b. Socioeconomic situation analysis of fish value chain in Angola: evidence from Moxico and Uíge Provinces. Draft.
- Mindjimba, K. & Tiotsop, F.** 2018. Factors determining FAO-Thiaroye processing technique adoption and sustainable use: evidence from selected sub-Saharan African countries. In FAO. *Report and papers presented at the fourth Meeting of Professionals/Experts in support of Fish Safety, Technology, and Marketing in Africa, Elmina, Ghana, 14–16 November 2017. Rapport et documents présentés à la quatrième réunion des professionnels/experts en appui à la sécurité sanitaire, à la technologie et au commerce du poisson en Afrique, Elmina, Ghana, 14–16 novembre 2017*, pp. 265–285. FAO Fisheries and Aquaculture Report / FAO Rapport sur les pêches et l'aquaculture No. 1228. Rome. 355 pp. (also available at www.fao.org/3/ca0374b/CA0374B.pdf).
- Ministère de la Pêches et de l'Aquaculture.** 2009. *Lettre de Politique de Développement de la Pêche et de l'Aquaculture (LPDPA): Bilan et Stratégie* [online]. [Cited 21 September 2018]. <http://extwprlegs1.fao.org/docs/pdf/gui158098.pdf>
- Ministère des Pêches, de l'Aquaculture et de l'Économie Maritime.** 2015. *Document Cadre de Politique des Pêches et de l'Aquaculture (DOCPA)* [online]. [Cited 21 September 2018]. http://peches.gov.gn/images/PDF/strategies_cadre_pland_eveloppement/Document-cadre-Politique-des-Pches-et-de--laquaculture.pdf
- Ministry of Fisheries and Aquatic Resources.** 2007. *Ten Year Development Policy Framework of the Fisheries and Aquatic Resources Sector 2007 – 2016* [online]. [Cited 21 September 2018]. www.cepa.lk/content_images/publications/documents/121-S-Min.of%20Fisheries-Ten%20year%20development%20policy.pdf
- Ministry of Fisheries and Aquatic Resources.** 2008. *National Policy and Strategy on Cleaner Production for Fisheries Sector* [online]. [Cited 21 September 2018]. <http://lk.chm-cbd.net/wp-content/uploads/2015/04/National-policy-and-strategy-oncleaner-production-for-fishery-sector.pdf>
- Ministry of Livestock and Fisheries Development.** 2015. *National Fisheries Policy of 2015* [online]. [Cited 21 September 2018]. <http://extwprlegs1.fao.org/docs/pdf/tan168881.pdf>
- Ndiaye, O.** 2015. *Projet d'appui à la valorisation et à la gestion durable des produits de la pêche artisanale TCP/GBS/3401*. Rapport de la seconde mission de la consultante internationale en valorisation. Secrétariat d'État à la Pêche / Organisation des Nations unies pour l'Agriculture et l'Alimentation. 36 pp.
- Ndiaye, O. & Diei-Ouadi, Y.** 2009. *De la pirogue à l'étal. Équipements améliorés de manutention et de transformation pour la pêche artisanale*. FAO Document technique sur les pêches et l'aquaculture No. 535. Rome, FAO. 2009. 75 pp. (also available at www.fao.org/docrep/012/i1139f/i1139f00.htm).

- Ndiaye, O. & Diei-Ouadi, Y.** 2012. Smoking healthy and eating healthy fish: performance of the FAO-Thiaroye system, an improved design of kiln with particular focus on the control of polycyclic aromatic hydrocarbons (PAH). *In* FAO. *Report and papers presented at the third Workshop on Fish Technology, Utilization and Quality Assurance in Africa*. Victoria, Mahe, Seychelles, 22–25 November 2011. *Rapport et documents présentés au troisième Atelier sur la technologie, l'utilisation et l'assurance de qualité du poisson en Afrique*. Victoria, Mahe, Seychelles, 22-25 novembre 2011, pp. 53–70. FAO Fisheries and Aquaculture Report / FAO Rapport sur les pêches et l'aquaculture No. 990. Rome, FAO. 263 pp. (also available at <http://www.fao.org/docrep/017/i3093b/i3093b.pdf>)
- Ndiaye, O., Komivi, B.S. & Diei-Ouadi, Y.** 2015. *Guide for developing and using the FAO-Thiaroye fish processing technique*. Rome, FAO.
- Needham, S. & Funge-Smith, S.J.** 2014. *The consumption of fish and fish products in the Asia-Pacific region based on household surveys*. Bangkok, FAO Regional Office for Asia and the Pacific. 87 pp. (also available at www.fao.org/3/a-i5151e.pdf).
- Njai, S.E.** 2000. *Traditional fish processing and marketing of the Gambia* [online]. UNU-Fisheries Training Programme. [Cited 21 September 2018]. www.unuftp.is/static/fellows/document/sirra3.pdf
- Nwankwo, O.N.O., Mokogwu, N., Agboghroma, O., Ahmed, F.O. & Mortimer, K.** 2018. *Knowledge, attitudes and beliefs about the health hazards of biomass smoke exposure amongst commercial food vendors in Nigeria*. PLOS ONE [online]. [Cited 21 September 2018]. <http://journals.plos.org/plosone/article?id=10.1371/journal.pone.0191458>
- Obasohan, E., Edward, E. & Oronsaye, J.A.O.** 2012. A survey on the processing and distribution of smoked catfishes (*Heterobranchus* and *Clarias* spp.) in Ekpoma, EDO State, Nigeria. *Research Journal of Recent Sciences*, 1(8): 23–28.
- Odoli, C.O.** 2015. *Drying and smoking of capelin (Mallotus villosus) and sardine (Sardinella gibbosa) – the influence on physicochemical properties and consumers acceptance*. University of Iceland. (dissertation). (available online at <https://skemman.is/handle/1946/23233>).
- Ofori, P.O.** 2017. Chorkor Smoker fish can cause cancer – Researchers recommend new technology. *In: Graphic Online* [online]. [Cited 21 September 2018]. www.graphic.com.gh/news/general-news/chorkor-smoker-fish-can-cause-cancer-researchers-recommend-new-technology.html
- Okyere-Nyako, A.A., Aziebor, E. & Robinson, J.** (undated). *Namhowfo, mangroves and woodlots: a more complete approach to reducing deforestation in Ghana* [online]. [Cited 21 September 2018]. www.snv.org/public/cms/sites/default/files/explore/download/case_study_-_mangroves_and_woodlots.pdf
- Peñarubia, O.R.** 2017. *Postharvest loss reduction in smoked fish value chains in tropical countries: a review of a market access driven intervention and prospects for developing countries*. *Save Food Innovationparc 2017* [slideshow]. [Cited 21 September 2018]. www.save-food.org/cgi-bin/md_interpack/lib/all/lob/return_download.cgi/FAO_Omar.pdf?ticket=g_u_e_s_t&bid=5702&no_mime_type=0
- Peñarubia, O.R., Randrianantoandro, A. & Diei-Ouadi, Y.** 2018. Background paper for the discussion on benchmarking of fish smoking systems in Africa: advances in fish smoking and perspectives for a sustainable food system in Africa. *In* FAO. *Report and papers presented at the fourth Meeting of Professionals/Experts in support of Fish Safety, Technology, and Marketing in Africa, Elmina, Ghana, 14–16 November 2017*. *Rapport et documents présentés à la quatrième réunion des professionnels/experts en appui à la sécurité sanitaire, à la technologie et au commerce du poisson en Afrique, Elmina, Ghana, 14-16 Novembre 2017*, pp. 332–344. FAO Fisheries and Aquaculture Report / FAO Rapport sur les pêches et l'aquaculture No. 1228. Rome, FAO. 355 pp. (also available at www.fao.org/3/ca0374b/CA0374B.pdf).

- Po, J.Y.T., FitzGerald, J.M. & Carlsten, C. 2011. Respiratory disease associated with solid biomass fuel exposure in rural women and children: systematic review and meta-analysis. *Thorax*, 66: 232–239.
- Pradhan, N.M., Shrestha, K., Rai, S., Jha, D.K. & Sah, S.K. 2017. Diversity and marketing of dried fish products in Nepal. *Journal of Agriculture and Forestry University*, 1: 139–152. (also available at http://afu.edu.np/sites/default/files/Diversity_and_marketing_of_dried_fish_products_in_Nepal_N._Pradhan.pdf).
- Randrianantoandro, A. 2015. *Assurance de la sécurité sanitaire et qualité des produits : les activités de la FAO pour la sécurité alimentaire et la connectivité aux marchés* [slideshow]. Rome, FAO. 18 slides. [Cited 21 September 2018]. <http://membersarea.globefish.org/upl/news/FTTFrance%20farany.pdf>
- Randrianantoandro, A. & Diei-Ouadi, Y. 2015. Climate-smart agriculture for fisheries: the FAO-Thiaroye fish processing technique. In: World Bank, FAO & IFAD. *Gender in Climate-Smart Agriculture. Module 18 for the Gender in Agriculture Sourcebook*. World Bank, FAO & IFAD. 84 pp. (also available at www.fao.org/3/a-i5546e.pdf).
- Rengarajan, T., Rajendran, P., Nandakumar, N., Lokeshkumar, B., Rajendran, P. & Nishigaki, I. 2015. Exposure to polycyclic aromatic hydrocarbons with special focus on cancer. *Asian Pacific Journal of Tropical Biomedicine*, 5(3), 182–189.
- Rogers, E.M. 2003. *Diffusion of innovations*. Fourth edition. New York, USA, The Free Press. 37 pp. (also available at www.d.umn.edu/~lrochfor/ireland/dif-of-in-ch01.pdf).
- Rosenthal, I. forthcoming. *Gender-related issues in small-scale fisheries in Burkina Faso, Côte d'Ivoire, Ghana and Tunisia. Potential pathways towards strengthening livelihoods and women's roles*. Rome, FAO.
- Rotawewa, B. & Wickramasinghe, K. 2018. Empowering women headed households and small scale inland fishery communities: experience and perspectives in shifting from traditional fish smoking to FTT-Thiaroye processing technique in Sri Lanka. In FAO. *Report and papers presented at the fourth Meeting of Professionals/Experts in support of Fish Safety, Technology, and Marketing in Africa, Elmina, Ghana, 14–16 November 2017. Rapport et documents présentés à la quatrième réunion des professionnels/experts en appui à la sécurité sanitaire, à la technologie et au commerce du poisson en Afrique, Elmina, Ghana, 14-16 novembre 2017*, pp. 238–250. FAO Fisheries and Aquaculture Report / FAO Rapport sur les pêches et l'aquaculture No. 1228. Rome, FAO. 355 pp. (also available at www.fao.org/3/ca0374b/CA0374B.pdf).
- Rural Finance and Investment Learning Centre (RFILC). 2018. Improving Capacity Building in Rural Finance (CABFIN). In: *RFILC* [online]. [Cited 21 September 2018]. www.ruralfinanceandinvestment.org/about
- Salaudeen, M.M., Osibona, A.O. & Akande G.R. 2018. Polycyclic aromatic hydrocarbons (PAHs) concentrations of stored smoked fish products. In FAO. *Report and papers presented at the fourth Meeting of Professionals/Experts in support of Fish Safety, Technology, and Marketing in Africa, Elmina, Ghana, 14–16 November 2017. Rapport et documents présentés à la quatrième réunion des professionnels/experts en appui à la sécurité sanitaire, à la technologie et au commerce du poisson en Afrique, Elmina, Ghana, 14-16 novembre 2017*, pp. 145–153. FAO Fisheries and Aquaculture Report / FAO Rapport sur les pêches et l'aquaculture No. 1228. Rome, FAO. 355 pp. (also available at www.fao.org/3/ca0374b/CA0374B.pdf).
- Salehe, M., Luomba, J., Musiba, M., Mlaponi, E. & Mghamba, K. 2014. Consumer preference on value added products of farmed fish in Lake Victoria Basin, Tanzania. *Asian Journal of Applied Science and Engineering*, 3: 28–33.
- Secrétariat Général du Gouvernement et du Conseil des Ministres (SGG-CM). 2015. *Decret N°2014790/PRES/PM/MRAH/MEF du 16 septembre 2014 portant adoption de la Politique Nationale de la Pêche et de l'Aquaculture au Burkina Faso (PNPA)*. JO N°47 de 2014. (also available at <http://extwprlegs1.fao.org/docs/pdf/bkf146170.pdf>).

- Senegal.** 2014. *Plan Sénégal Émergent* [online]. [Cited 21 September 2018]. www.sec.gouv.sn/sites/default/files/Plan%20Senegal%20Emergent_0.pdf
- Sérot, T., Baron, R., Cardinal, M., Cataneo, C., Knockaert, C., Le Bizec, B., Prost, C., Monteau, F. & Varlet, V.** 2009. Assessment of the effects of the smoke generation processes and of smoking parameters on the organoleptic perception, the levels of the most odorant compounds and PAH content of smoked salmon fillets. In *FAO. Report and papers presented at the second workshop on fish technology, utilization and quality assurance in Africa*. FAO Fisheries and Aquaculture Report No. 904. Rome, FAO. 201 pp. (also available at www.gbv.de/dms/sub-hamburg/608705691.pdf).
- SFP Info.** 2010. *Improved smoking technique to make exports to the EU market possible* [online]. [Cited 21 September 2018]. http://sfp.acp.int/sites/all/files/sfp-info/newsSFP14_en_LR.pdf
- SNV Netherlands Development Organisation.** 2017. Introducing the Ahotor oven in the Volta Region of Ghana. In: *SNV* [online]. [Cited 21 September 2018]. www.snv.org/update/introducing-ahotor-oven-volta-region-ghana
- SOFRECO.** 2011. *Amélioration des politiques et des systèmes de gestion des pêches dans les pays du sud du Golfe de Guinée (Cameroun et Guinée Equatoriale). Rapport technique final (19 Avril 2011)* [online]. [Cited 21 September 2018]. <http://acpfish2-eu.org/uploads/projects/id50/FTRGb-01.pdf>
- SOFRECO.** (undated). *Amélioration des politiques et des systèmes de gestion des pêches dans les pays du sud du Golfe de Guinée – Cameroun et Guinée Equatoriale. Document Cadre des Politiques des Pêches et de l’Aquaculture en Guinée Equatoriale (DCP-PAGE). Version Provisoire* [online]. [Cited 21 September 2018]. <http://acpfish2-eu.org/uploads/projects/id50/I1427%20Guin%C3%A9%20Cadre%20Politique%20Version%20STR%2015%2003%202011.pdf>
- Technavio.** 2017. *Global Smoked Fish Market 2017-2021 Report*. 70 pp. (also available at <https://www.technavio.com/report/global-food-global-smoked-fish-market-2017-2021>).
- Thilsted, S.H., James, D., Toppe, J., Subasinghe, R.P. & Karunasagar, I.** 2014. *Maximizing the contribution of fish to human nutrition* [online]. ICN2 Second International Conference on Nutrition: better nutrition better lives. [Cited 21 September 2018]. www.fao.org/3/a-i3963e.pdf.
- Tongo, I., Ogbeide, O. and Ezemonye, L.** 2017. Human health risk assessment of polycyclic aromatic hydrocarbons (PAHs) in smoked fish species from markets in Southern Nigeria. *Toxicology Reports*, 4: 55–61. (also available at <http://dx.doi.org/10.1016/j.toxrep.2016.12.006>).
- Toppe, J., Bondad-Reantaso, M.G., Hasan, M.R., Josupeit, H., Subasinghe, R.P., Halwart, M. & James, D.** 2012. Aquatic biodiversity for sustainable diets: the role of aquatic foods in food and nutrition security. In *Burlingame, B. & Dernini, S., eds. Sustainable diets and biodiversity*, 94–101. Rome, FAO. (also available at www.fao.org/docrep/016/i3004e/i3004e.pdf).
- Tous, P.** 2017. *Assistência técnica no domínio das estatísticas de pesca artesanal continental. Fase de preparação do Inquérito Quadro*. Relatório de missão. Versão final. Projeto UTF/ANG/058 – Assistência Técnica para uma pesca responsável e a utilização dos produtos pelas comunidades piscatórias continentais.
- Traoré, K.S.** undated. *Étude sur la toxicité des emballages et des combustibles utilisés dans le fumage des produits halieutiques en Côte d’Ivoire*. Ministère de l’Agriculture et du Développement rural, Laboratoire National d’Appui au Développement Agricole (LANADA). (PowerPoint document).
- Turow, E.** 2011. Colonizers’ influence infuses Southeast Asian cuisine. In: *NPR* [online]. [Cited 21 September 2018]. www.npr.org/2011/10/18/141465353/colonizers-influence-infuses-southeast-asian-cuisine?t=1531134941169

- Umoh, V.A. & Peters, E. 2014. The relationship between lung function and indoor air pollution among rural women in the Niger Delta region of Nigeria. *Lung India: Official Organ of Indian Chest Society*, 31(2), 110–115. (also available at <http://doi.org/10.4103/0970-2113.129815>).
- United Nations Commodity Trade Statistics database (UN Comtrade). ongoing. *Fish cured, smoked, fish meal for human consumption. Detail data availability by reporting countries*. (Available online at <https://comtrade.un.org/db/mr/rfCommoditiesList.aspx?px=H1&cc=0305>).
- United Nations Department of Economic and Social Affairs, Population Division (UNDESA). 2017. *World Population Prospects 2017* [online]. [Cited 21 September 2018]. <https://esa.un.org/unpd/wpp/>
- Vrutti Livelihood Resource Centre. 2008. *Developing a marketing strategy for fisheries intervention aiming at livelihood promotion in Bundelkhand Region of India – a value chain based assessment and planning* [online]. [Cited 21 September 2018]. www.vrutti.org/images/documents/DevelopingaMarketingStrategyForFisheriesValueChain.pdf
- West African Economic and Monetary Union (WAEMU). 2012–14. *Système d'Information Régional des Pêches de l'UEMOA* [online]. [Cited 21 September 2018]. <http://atlas.statpeche-uemoa.org>
- Ward, A. 2003. *A study of the trade in smoked-dried fish from West Africa to the United Kingdom*. FAO Fisheries Circular No. 981. Rome, FAO. 17 pp. (also available at www.fao.org/tempref/docrep/fao/006/y4530e/y4530E00.pdf).
- Weichselbaum, E., Coe, S., Buttriss, J. & Stanner, S. 2013. Fish in the diet: a review. *Nutrition Bulletin*, 38: 128–177.
- Wibowo, S., Ward, A.R., Diei-Ouadi, Y., Susana, S. & Suuronen, P. 2017. *Case studies on fish loss assessment of small-scale fisheries in Indonesia*. FAO Fisheries and Aquaculture Circular No. 1129, 2017. Rome, FAO. (also available at www.fao.org/3/a-i6282e.pdf).
- World Bank Group, FAO & IFAD. 2015. *Gender in Climate-Smart Agriculture: Module 18 for the Gender in Agriculture Sourcebook*. Agriculture Global Practice. World Bank Group Report Number 99505-GLB. 84 pp. (also available at www.fao.org/3/a-i5546e.pdf or www.fao.org/tempref/docrep/fao/011/aj288e/aj288e.pdf).
- World Bank. 2011. *Missing Food: The case of postharvest grain losses in Sub-Saharan Africa* [online]. Report No. 60371-AFR. [Cited 21 September 2018]. https://siteresources.worldbank.org/INTARD/Resources/MissingFoods10_web.pdf
- World Health Organization (WHO). 2006. *Air Quality Guidelines Global Update 2005, particulate matter, ozone, nitrogen dioxide and sulfur dioxide*. (also available at www.euro.who.int/__data/assets/pdf_file/0005/78638/E90038.pdf).
- Zanzibar. 2014. Zanzibar Fisheries Policy [online]. [14 September 2018]. www.kilimoznz.go.tz/policy/fisheries_Policy_.pdf
- Ziehi, A. 2016. *Réduction des pertes post-capture des produits halieutiques (PCT/IVC/3501)*, Représentation de la FAO en Côte d'Ivoire, 9ème MDT – Lomé – 17-20 mai 2016. (PowerPoint Document).
- Zinsou, J. & Wentholt, W. 1989. *Guide pratique pour la construction et l'introduction du fumoir "Chorkor"*. DIPA/WP/24. Cotonou, Projet DIPA. 33 pp. (also available online at www.fao.org/3/a-an063f.pdf).

SUMMARY OF PRECONDITIONS FOR SUCCESS OF FTT PROJECTS

Preconditions for success

What went well!

Precondition 1: The superiority of the FTT over traditional systems for smoking fish is a necessary but not sufficient condition for the adoption of this new technology in order to reap the anticipated benefits. Other conditions must be taken into consideration, including the prevailing business environment and consumer behaviour and awareness concerning FTT and traditional products

Precondition 2: The FTT is most likely to be successfully introduced in a country and to achieve its stated goals when food security and nutrition are embedded in national fisheries and aquaculture policies and enforcement is effective.

Examples of FTT project results

- FTT hailed as an effective and efficient solution for the problems posed by traditional fish processing systems and appreciated by an overwhelming majority of fish processors (mainly but not exclusively women) for its attributes.
- Comparative advantages of FTT and its products over traditional systems for smoking fish well documented as are the reasons for dissemination of this innovation.
- Financial and economic profitability of FTT demonstrated.
- Producer organizations (POs) set up in Côte d'Ivoire and Ghana.
- National fisheries and aquaculture policies devised and adopted.
- Some of these policies aligned with international and regional policy instruments.
- Current and potential significance of the sector recognized in most of these policies.
- Sustainable management of the sector and its resources as well as food security further underlined in some of these policies, especially in the face of declining fish stocks, magnitude and occurrence of high post-harvest fish losses and waste, therewith providing an appropriate framework for the FTT's dissemination.
- PAHs included in fisheries regulations in Côte d'Ivoire.
- Nationwide risk assessment of PAHs in smoked fish conducted and FTT integrated in the curriculum of the University of Ghana in Ghana.

What did not go well!

Food security and nutrition (FSN) not incorporated among the policy pillars in national fisheries and aquaculture policies in all country case studies.

Weak policy enforcement.

Dearth of efforts to promote FTT products on domestic markets.

Policies usually translated into strategic plan for export markets only.

Poor design and management of FTT infrastructure.

Absence of conducive and enabling business environment, notably in terms of price differentiation and quality labelling between FTT and traditional products on the local and domestic markets.

Low sensitization and education of the population about the comparative advantages of FTT products, especially with respect to their higher quality and safety.

*Recommendations³**For Precondition 1:*

- Devise policy actions and market incentives in support of enhanced consumer acceptance of FTT products, given their attributes, by enabling and encouraging consumers to make more nutritious choices.
- Revise the fisheries regulatory framework governing PAHs with a view to ensuring fishery products traceability and quality control.
- Provide support to market information system.
- Connect smallholders and producer organizations (POs) or clusters of innovation or outstanding community leaders to agribusiness through productive partnerships in order to collectively safeguard their interests, and mainstream this in national fisheries and aquaculture policies.
- Spur a culture of excellence with a framework for nationwide competition, rewarding best practices.
- Target export market as workable entry point / early action.
- Target species that are in high demand as smoked fish such as catfish.

For Precondition 2:

- Revise national fisheries and aquaculture policies by incorporating FSN among the policy pillars where this is not the case.
- Enhance the enforcement mechanisms in place to ensure the existing fisheries policy, legal and regulatory frameworks are effectively complied with.

¹ These constitute strengths or critical success factors.

² These constitute weaknesses, failures and challenges that have unintended outcomes (areas to improve).

³ Recommendations about what should change in later project stages and future projects.

Sources: Anoh *et al.* (2018); Global Panel (2017); Mindjimba and Tiotsop (2018).

SUMMARY OF LESSONS LEARNED FROM FTT PROJECTS IN SELECTED SUB-SAHARAN AFRICAN AND ASIAN COUNTRIES, WITH RECOMMENDATIONS FOR LATER PROJECT STAGES AND FUTURE PROJECTS

Project phase	Key lessons learned
<p data-bbox="868 1899 916 2024">Planning and design</p>	<p data-bbox="564 958 587 1256">Examples of FTT project results</p> <ul data-bbox="595 327 643 1234" style="list-style-type: none"> • Preparatory activities conducted in Burkina Faso, Côte d'Ivoire and Ghana prior to setting up FTT platforms to ensure a much smoother uptake by actors along the value chain.
	<ul data-bbox="671 264 1126 1256" style="list-style-type: none"> • Sites harbouring FTT infrastructure located on communal and municipal lands availed free of charge in most country case studies. • Two sites for the construction of post-harvest technological platforms planned in Mulondola and Val do Loge in Angola jointly selected by the competent authorities, local authorities and FAO. • Existing pathways altered and warehouses harbouring FTT platforms in Guessabo and Marcory-Anoumabo in Côte d'Ivoire funded by the Regional Council of Haut-Sassandra and Marcory Municipality, respectively. • Ancillary jobs created for local artisans to craft FTT components around the four pilot FTT platforms in Côte d'Ivoire (Abobo-Doumé, Braffedon, Guessabo and Marcory-Anoumabo) and for the construction of the Ngolome post-harvest technological platform in Angola. • Capacities of intended groups of fisheries operators (mainly women fish processors) and fisheries extension workers purposely developed or upgraded in most country case studies for them to better carry their productive activities and run the FTT infrastructure made available to them (e.g. 52 fisheries extension workers, 50 fisheries operators around Lake Ngolome in Angola, 50 women fish processors in Burkina Faso, 30 fisheries group leaders comprising 23 women in Burundi, groups of fish processors structured in cooperatives and some 2 500 of these women trained in Côte d'Ivoire, 50 women fish processors and 10 fisheries officers in Guinea-Bissau, groups of fisheries students in the United Republic of Tanzania, group of women fish processors in Sri Lanka). • Design of FTT-Dafig kiln in Burkina Faso. <p data-bbox="1106 1294 1214 1845">Lesson 4: The technical specifications (especially the capacities), construction and dissemination of future FTT prototypes must be consistent with the prevailing fisheries status and potential as well as existing practices and market needs.</p>

Project phase	Key lessons learned	What did not go well?	Recommendations ^a
Planning and design	<p>What did not go well?</p> <p>Top-down approach adopted in establishing FTT units (e.g. FTT kilns installed in six artisanal fisheries communities in Cameroon).</p> <p>Low target group and community participation in that regard (e.g. in Cameroon).</p> <p>Low sensitization and education of the population in most country case studies (except in Côte d'Ivoire) on the comparative advantages of the FTT and its products <i>vis-à-vis</i> other systems for smoking fish.</p> <p>Individualism of fishers and fish processors despite their organization in cooperative societies.</p> <p>Leadership conflicts resulting in split of cooperatives into mini-cooperatives.</p> <p>Weak group dynamics (women generally more concerned with trading and domestic chores):</p> <p>Weak cooperative linkages and networking.</p> <p>Weak group capacity and functionality.</p> <p>Little decision-making power of women in family dynamics and low access to productive resources.</p> <p>Absence of promotion and marketing of FTT products.</p> <p>FTT products and those resulting from traditional methods generally sold on same markets and under same conditions.</p> <p>Consumers hesitant before FTT products because of their lighter colour for not being aware and educated on the higher quality and safety of these products.</p> <p>Non-price differentiation between FTT and traditional products on local and domestic markets (e.g. in Côte d'Ivoire, Democratic Republic of the Congo and United Republic of Tanzania, except in Sri Lanka).</p> <p>Some consumers in Burkina Faso and Côte d'Ivoire unaware of the availability of FTT products and where to find them.</p> <p>Most FTT kilns underutilized.</p>	<p>Recommendations^a</p> <p>For Lesson 1:</p> <ul style="list-style-type: none"> • Adopt a sequencing approach for the introduction of the FTT in a given context as this enhances uptake by value chain actors. <p>For Lesson 2:</p> <ul style="list-style-type: none"> • Adopt a participatory approach with key stakeholders in all phases of the development process of FTT projects. • Facilitate and support stakeholder and community participation and engagement through adequate sensitization and education (see Lesson 6 below). • Select the site to harbour the FTT infrastructure judiciously to foster it being reachable by the greatest number of potential users, and make sure that the intended community participates in the site selection process. This generally entails a compromise among several criteria such as concentration of fish processors, distance, servicing and security. <p>For Lesson 3:</p> <ul style="list-style-type: none"> • Draw inspiration from the prerequisites identified in Herbel <i>et al.</i> (2012) to create or transform professional groups into highly beneficial institutions. • Adopt good practice to achieve effectiveness and sustainability. • Empower the target groups (including women fish processors), and develop or upgrade their capacities and those of the agents responsible for following up their activities and providing guidance in order for them to better carry out their productive activities and to run the infrastructure more effectively and efficiently. • Empower platform champion women members through professional training to give them the knowledge and confidence to negotiate contracts with different markets than the ones they are familiar with. • Revitalize the grassroots and umbrella organizations in each segment of the value chain and set up an intersegment organization and a channel of communication or consultation between the segments of the value chain's different levels. • Set up institutional arrangements ensuring excellent post-harvest extension accompanying improved technology and adequate infrastructure, including proper storage facilities. • Set up a system of record-keeping through the fisherfolk professional groups in order to bring about better resource management and a clearer understanding of the sector, allowing to plan the development of the sector in a sustainable and profitable way. • Allow only well-structured and organized socioprofessional groups to run the FTT infrastructure in communal settings. • Facilitate the structuring and organization of beneficiary groups. <p>For Lesson 4:</p> <ul style="list-style-type: none"> • Set up a sound statistical data system in support of the processing domain and market information conducive to a consistent commercial partnership establishment. • Match the design of FTT prototypes with the prevailing fisheries status and potential as well as market needs of the local/national context and prevailing customs. • Improve the product (fresh and smoked fish) quality by increasing the awareness women processors, fishmongers and also fishers to transform bad practices with capacity development programmes on good fishing practices, handling and hygiene, especially at the level of fishing. • Document reduced fish loss and waste, thanks to the FTT, thereby easing some of the pressure on fisheries resources. • Ensure that FTT products meet market needs and requirements particularly in terms of, traceability, and packaging consistent volume and product quality, frequency and regularity of supplies. 	

Project phase	Key lessons learned
Implementation and monitoring	<p>What went well!</p> <p>Lesson 5: Only those with the proper practical experience and skills on FTT kilns should be tasked with designing and constructing them and with training others in their use.</p> <p>Lesson 6: Adopting a stepwise approach in implementing FTT projects increases chances of success and minimizes risks of failure.</p> <p>Lesson 7: FTT management arrangements need to be clearly defined and partners' respective roles and responsibilities in that regard clarified early in the project.</p> <p>Lesson 8: Empowering women fish processors in carrying out their productive activities and in managing their income strengthens their autonomy.</p> <p>Lesson 9: Linking all actors to markets by supporting marketing and product-differentiation activities enhances livelihoods.</p> <p>Lesson 10: Sensitizing and educating the public at large on the comparative advantages of the FTT and its products enhance likelihood of product buy-in and consumption.</p> <p>Lesson 11: Developing ecology and green energy alternatives and alternative income-generating activities enhances value chain actors' economic and climate change resilience.</p> <p>Lesson 12: Project teams and sponsors need to effectively monitor FTT projects.</p>
	<p>Examples of FTT project results</p> <ul style="list-style-type: none"> • Pilot FTT platforms and kilns in Côte d'Ivoire, Democratic Republic of the Congo and United Republic of Tanzania designed and constructed by FAO, technology transferred to the local fishery officers and artisans. • Four pilot FTT platforms in Côte d'Ivoire run by women fish processors and traders grouped in cooperatives. • Stepwise approach adopted by the Government of Angola in establishing post-harvest technological FTT platforms country (including FTT kilns) across the country with technical assistance from FAO. • FTT kilns designed to suit local needs (e.g. FTT-Daifing in Burkina Faso, detachable FTT in Nigeria). • Pilot FTT platforms moulded to the local environment and needs from site to site in Côte d'Ivoire. • Ngolome post-harvest technological platform in Angola financially supported by the Government and jointly managed by a private enterprise (SANESAL) through a protocol agreement with representatives of the riparian fisheries communities.
	<ul style="list-style-type: none"> • Women fish processors and traders in Côte d'Ivoire sensitized and educated on post-harvest fish loss (PHFL) resulting from traditional methods and the comparative advantages of the FTT. • Clusters of women fish processors set up in Burkina Faso and Côte d'Ivoire. • FTT products at the platform level differentiated from those derived from traditional methods and commercial relations established with more rewarding markets in Burkina Faso and Côte d'Ivoire. • More aggressive marketing strategies adopted by Women Fish Traders and Processors Cooperative of Abidjan (CMATPHA) in Côte d'Ivoire to boost sales of FTT products from their platform in Abobo-Doumé, including the possibility of exporting to the market of the European Union (Member Organization).
	<ul style="list-style-type: none"> • Income-generating activities (IGAs) – e.g. sale of food packaging items, washbasins, salt, diversifying and adding value to fishery products and by-products, internal savings and loan system – carried out on these platforms besides fish processing. • Technology transferred to local artisans in crafting FTT components in Côte d'Ivoire. • At present, urban centres as the main markets for improved smoked products.
	<ul style="list-style-type: none"> • Performance (technology, quality and safety of products) of FTT kilns now formally established. • Communication and promotional materials for FTT products developed (FAO didactic videos and other videos produced by local television channels, flyers, kakemonos) in Côte d'Ivoire but yet to be distributed to the general public.
	<ul style="list-style-type: none"> • IGAs and an internal savings and loan system carried out by women cooperatives on FTT pilot platforms in Côte d'Ivoire. • Use of alternative fuels (other than wood) such as agricultural residues and waste as well as heat-retention stones (e.g. siporex) to smoke fish.
	<ul style="list-style-type: none"> • Two outreach young fisheries professionals appointed by FAO Office in Côte d'Ivoire for the guidance of women fish smokers on two of the four pilot FTT platforms in Braffedon and Guessabo and monitoring of their activities.

Project phase	Key lessons learned
What did not go well?	<ul style="list-style-type: none"> • Recommendations³
Inappropriate design and construction of FTT kilns (e.g. in Cameroon).	<ul style="list-style-type: none"> • For Lesson 5: <ul style="list-style-type: none"> • Develop and/or upgrade the skills of the extension workers and field officers in community approach techniques such as participatory rural appraisal. • Task only those with the proper practical experience and skills in FTT kilns with designing and constructing them and with training others in their use, especially those destined for communities. • In order to have local building expertise, ensure proper training of local artisans. • Test and demonstrate the facilities and equipment during installation.
Absence of testing and demonstration during installation.	<ul style="list-style-type: none"> • For Lesson 6: <ul style="list-style-type: none"> • Adopt a stepwise approach in implementing any FTT project as this increases chances of success and reduces risks of failure.
Lack of guidance and follow-up.	<ul style="list-style-type: none"> • For Lesson 7: <ul style="list-style-type: none"> • Decide on the management arrangements of presently existing or future FTT infrastructure by clarifying partners' respective roles and responsibilities in that regard early in the project. • Select only honest and efficient operators (based on their reputation) to run the infrastructure and formalize the contractual arrangements through a memorandum of understanding (MoU) or protocol agreement. • Ensure provision (under the MoU) for dismissal of operators whose honesty and efficiency are questioned or not proved.
Pilot FTT kilns in Cameroon installed immediately from one site to another without learning a lesson from previous sites.	<ul style="list-style-type: none"> • For Lesson 8: <ul style="list-style-type: none"> • Empower women fish processors in carrying out their productive activities (fish processing, and marketing) and in managing their income through tailor-made training programmes. • Devise ways to ensuring equity in all activities. • Facilitate women fish processors' access to microcredit for productive activities. • Adopt a gender-sensitive value chain approach that focuses on market dynamics. • Identify and explore more lucrative markets through contract-selling and sustainable practices, as this improves marketing conditions.
Remote monitoring of most FTT projects.	<ul style="list-style-type: none"> • For Lesson 9: <ul style="list-style-type: none"> • Facilitate organization of raw material purchases. • Support management of fish smoking and storage platform as well as inputs, quality assurance, labelling and packaging practices, and volumes of products sold. • For Lesson 10: <ul style="list-style-type: none"> • Sensitize and educate the general public on FTT products benefits, including the value for money and comparative advantages through awareness campaigns and relevant channels such as radio and television programmes, press campaigns, participation in fairs, awareness caravans.
	<ul style="list-style-type: none"> • For Lesson 11: <ul style="list-style-type: none"> • Develop ecology and green energy alternatives. • Develop alternative sources of IGAs as this enhances value chain actors' economic and climate change resilience.
	<ul style="list-style-type: none"> • For Lesson 12: <ul style="list-style-type: none"> • Set up a collective monitoring mechanism by the local extension services and project team. • Define and reach consensus beforehand on monitoring modalities, including the benefits each actor or group of actors is likely to reap. • Set up a data collection and monitoring system for FTT activities and connected activities. • Document the effects of technological innovations as compared with traditional smoking kilns.

Implementation and monitoring

Project phase	Key lessons learned
	<p data-bbox="247 1668 272 1870">What went well¹</p> <p data-bbox="279 235 343 1870">Lesson 13: Institutionalizing lessons learned and strengthening the culture of experiential learning are good practices for success.</p>
Evaluation	<p data-bbox="359 1668 384 1870">What did not go well²</p> <p data-bbox="391 1310 416 1870">Lessons learned yet to be institutionalized in the country case studies.</p> <p data-bbox="438 1310 486 1870">Opportunistic set-up of cooperatives to gain access to a modern fish-processing platform.</p> <p data-bbox="247 952 272 1265">Examples of FTI project results</p> <ul data-bbox="279 235 343 1265" style="list-style-type: none"> • Exchange visits organized between FTI projects for groups of fish processors and fishers as well as fisheries officers (from Angola to Senegal and United Republic of Tanzania, from Burkina Faso to Côte d'Ivoire, and from Ghana to Côte d'Ivoire). <p data-bbox="359 1064 384 1265">Recommendations³</p> <p data-bbox="391 1120 416 1265">For Lesson 13:</p> <ul data-bbox="422 235 502 1265" style="list-style-type: none"> • Institutionalize the lessons learned. • Strengthen the culture of experiential learning in the FTI development process. • Organize in-country exchange visits between FTI projects and possibly exchange tours abroad to similar FTI projects for fish value chain actors.

¹ These constitute strengths or critical success factors.

² These constitute weaknesses, failures and challenges that have unintended outcomes (areas to improve).

³ Recommendations about what should change in later project stages and future projects.

Sources: Akoun (2018); Anoh *et al.* (2018); Mindjimba (2017a, 2017b); Mindjimba and Tiotsop (2018); Ziehi (2016).

More than 60 percent of global production of smoked fishery products occurs in Africa and Asia, highlighting their tremendous significance in food and nutrition security, as well as livelihood support in these regions. However, prevailing processing technologies present critical challenges, especially in terms of safety and quality aspects, and thus there is an urgent need for the development of more efficient and safer systems. The FAO-Thiaroye fish processing technique (FTT) was developed to address these challenges by yielding products that comply with international limits on polycyclic aromatic hydrocarbons in particular, while fostering many social, economic and environmental benefits. This document examines the conditions in which improved fish smoking systems in general, and the FTT in particular, have been adopted in the context of benefits, trade-offs and policy implications in selected developing countries. In fact, experience from some African and Asian countries points to the need for a context-driven balance that ensures that the gains associated with the use of this new technique can be realized without making expensive compromises, especially in terms of fisheries resources status and trade dynamics. Policy and regulatory frameworks need to be informed by a risk-based approach and supportive of consistent benchmarking and differentiation of FTT products. This document reviews the lessons from those countries, and makes the case for a hard, evidence-based, policy backbone to safeguard the sustainable, eco-friendly supply of safe smoked (and dried) fishery products to support food security, particularly in the developing world. It aims to enlighten policy makers, fisheries planners and decision makers and any development practitioner interested in developing small-scale fisheries or promoting sustainable food systems, as well as private sector entrepreneurs who wish to implement this technology to improve their products. It provides recommendations on how best to mainstream consumers' interests while supporting sustainable livelihoods interventions in fisheries communities.

ISBN 978-92-5-131469-2 ISSN 2070-7010



9 7 8 9 2 5 1 3 1 4 6 9 2

CA4667EN/1/05.19